

PROXXON

Tools with Character!



2019/2020



PROXXON socket sets – manufactured using most modern production

technology in the world's largest cold forging hand tool factory.



The ratchet – the key item :

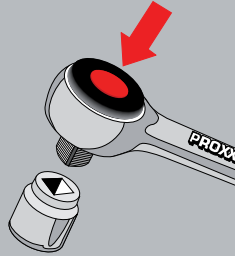

Made from CrV steel in one single piece. Hardened and with perfect toothing: several of the 52 teeth engage simultaneously for transmitting extremely high torque.
 Quick release mechanism: releasing sockets at the push of the button.
 Optimum surface protection: twice nickel plated then chromed in matt finish.
 Non-detachable handle made from oil and acid-resistant TPR (thermoplastic rubber) with practical hole for hanging up.

The PROXXON driver system:

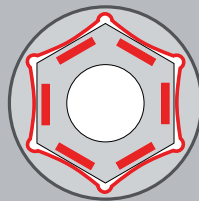

The driving force is applied to the flanks, not the corners. This ensures high power transmission without damaging the corners of the nut or bolt.

Screwdriver bits:

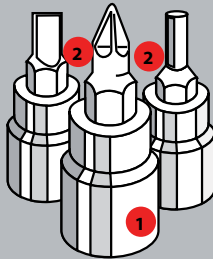

With CrV socket **1** .
 The drive bits are all an optimum combination of chrome-silicon-manganese-molybdenum steel **2** .



All bits and accessories are forged using 31CrV steel.

High carbon content to ensure consistent hardness. **3**
 Deep, uniform forging is fully guaranteed on the hex. drive side **4**
 to ensure that protruding studs do not present a problem. Thin-wall construction **5** for better access while maintaining strength for heavy work. Lead-in chamfer allows socket to slide over nuts easily. Machined fits on drive square **6** allow ratchet to arrest properly. Beginning with the 19mm size the outer diameter **7** of the sockets is reduced on the drive square end for improved handling **8** .
 Optimum surface protection: Double nickel-plating and single matt-finished chrome-plating.

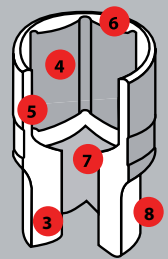

Quality at its best:

Highest quality, exceeds DIN/ISO requirements for hardness and maximum torque. Individual size tolerances are all well within the prescribed norms.



2 year guarantee

For full professional use!

Sockets and drive elements carry an additional **25 year guarantee** against faulty material and workmanship.



Socket sizes easy to read due to laser marking!

Socket sets in sturdy, powder-coated steel cases. Made from chrome vanadium

steel 31 CrV 3. 100,000fold workshop proven classics.

PROXXON

INDUSTRIAL

**DIN
ISO**

Highest quality, exceeds DIN/ISO requirements for hardness and maximum torque. Individual size tolerances are all well within the prescribed norms.

**2 year
guarantee**

For full professional use!

Sockets and drive elements carry an additional **25 year guarantee** against faulty material and workmanship.

For socket sets our test mechanics prefer steel cases: They are sturdy and preminently compact – a lot of tools, clearly arranged, requiring small space.

A chart for threads from M 1.6 – M 24 with related tightening torque is durably fixed inside the lid.



Herstellung nach
Certificate of Registration
File No. A10048 vom 09.02.01
ISO 9001:2000

With distortion-free, indestructible trays of injected POLYPROPYLENE. Oil and acid resistant and easy to clean. With easy-to-read and durable marking of all socket sizes!

**29-piece socket set for powerful mechanical work.
With 1/2" ratchet.**

Sockets from 8 – 34mm (the latter for M 22 according to the new ISO standard). Deep sockets in sizes 13 – 17 and 19mm for protruding bolts. Spark plug sockets 16 and 21mm. See photo for full contents.

NO 23 000



The high-strength POLYPROPYLENE trays are ideal for use in the drawers of common workshop tool-trolleys.

Note:

Our test mechanics do not approve of trays clamping the tools. Removing and putting back the tools should be possible with two fingers only.



Hands-on tools: Intelligent selection to suit fine mechanics to

heavy duty projects!



56-piece set with 1/4" and 1/2" ratchets

Contains sockets from 4mm to 32mm and 16/21mm spark plug sockets, screwdriver bits with square drive for slotted, Phillips, TX (with frontal hole) and Allen sockets and 1.25 – 1.5 – 2 – 2.5 and 3mm angled Allen keys.

[See photo for full contents.](#)

NO 23 040



27-piece automotive socket set with 1/4" and 1/2" ratchets

Suitable for all common sizes between 6mm and 32mm. Also contains 16 and 21mm spark plug sockets.

[See photo for full contents.](#)

NO 23 020



24-piece TX socket set

This set contains 1/4" drive (6.3mm) TX sockets in sizes TX8 to TX30 (with frontal hole) and external TX sizes E4 to E10 (all suitable for tightening torques up to 25Nm), 1/2" drive (12.5mm) TX sockets in sizes TX40 – 60 and external TX E12 to E20 (for tightening torques from 25 to 135Nm) and three offset TX spanners – the TX6, 8 and 10.

[See photo for full contents.](#)

NO 23 102



18-piece special set for Allen screws

For 1/4" square drive (6.3mm) and tightening torques up to 25Nm. Sizes 2 – 6mm.

For 1/2" square drive (12.5mm) and tightening torques from 25 – 210Nm: sizes 6 – 14mm (short version 55mm) and sizes 5 – 12mm (long version 100mm).

[See photo for full contents.](#)

NO 23 100



18-piece special set for XZN multi-toothed screws

For motor (cylinder head), drive shafts, rear axles. Includes 1/2" square drive. Screwdriver bits 5 – 14mm in normal version (55mm) and 6 – 14mm in extra-long version (100mm). Also includes outside double-hexagon inserts 9 – 21mm.

NO 23 296

With clearly readable sizes due

to laser marking.

Screwdriver handle with 1/4" square drive. 1/4" rear end connector to fit a ratchet or a T-bar.



36-piece precision engineer's set with 1/4" ratchet

Includes 4 – 13mm sockets, screwdriver bits with square drive for slotted, Phillips, TX (with frontal hole) and Allen sockets as well as 1.25 – 1.5 – 2 – 2.5 and 3mm angled Allen keys. [See photo for full contents.](#)

NO 23 080

39-piece screwdriver set with 1/4" ratchet and magnetic holder

For use with a drilling machine: 4 – 14mm sockets 1/4" drive (6.3mm). Includes 16 high quality alloy Allen key bits and adapters for male hex and square bits (magnet to socket adapter) and female hex and square bits (ratchet to screwdriver bit adapter) and 1.25 – 1.5 – 2 – 2.5 and 3mm angled Allen keys. [See photo for full contents.](#)

NO 23 070

32-piece precision engineer's socket set with 1/4" MICRO compact ratchet and sockets with strong magnetic inserts.

 Sockets from 5 – 13mm. In addition one each extension 50, 100 and 150mm: Nuts and screws are held securely even when working in tubes or pipes. 17 standard bits (25mm) made of high alloy special steel. Also includes hexagon/square female adapter. [See photo for full contents.](#)

NO 23 078

24-piece compact socket set with 3/8" ratchet

For 6 – 24mm. Including spark plug sockets 16 – 18 and 21mm. [See photo for full contents.](#)

NO 23 110

65-piece super compact socket set with 3/8" ratchet

Sockets from 6 – 24mm. Deep sockets for protruding bolts 10 – 13 – 15 and 17mm. Spark plug sockets 14 – 16 – 18 and 19mm. Screwdriver bits with square drive for HX, TX and XZN screws. 8 angled keys: HX 1.25 – 1.5 – 2 – 2.5 and 3mm as well as TX 6 – 8 and 10. [See photo for full contents.](#)

NO 23 112

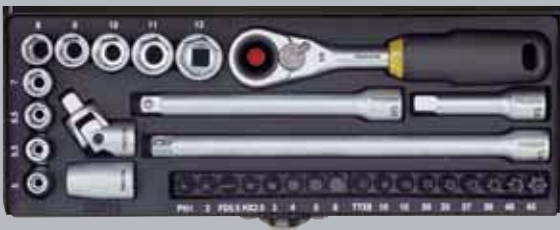

Six popular socket sets in compact plastic cases.

Solid, with sturdy tray and snap-lock.

PROXXON

INDUSTRIAL



Composition and design copyright by PROXXON.



65-piece complete set with 1/4" and 1/2" baton ratchets.

With 34mm socket (according to new ISO standard for M 22).

This 65 piece set offers sockets from 4 to 34mm, as well as 16 and 21mm spark plug sockets. Screwdriver bits with square drive for slotted, Phillips, TX (with frontal hole) and Allen sockets. Angled Allen keys 1.25 – 1.5 – 2 – 2.5 and 3mm. Four extensions, one screwdriver handle with square drive, two universal joints.

[See photo for full contents.](#)

NO 23 286

65-piece complete set for imperial sizes with 1/4" and 1/2" baton ratchets



Sockets from 5/32" – 1 3/8". Spark plug sockets 5/8" and 13/16". Screwdriver bits with square drive for slotted, Phillips, TX (with frontal hole) and Allen screws. Five angled Allen keys from 0.05" to 1/8". Four extensions. Two universal joints. Screwdriver handle with square drive.

[See photo for full contents.](#)

NO 23 294



For imperial screw sizes from 5/32" to 1 3/8".

47-piece compact set with 3/8" baton ratchet



This 47 piece set offers sockets from 6 – 24mm. Deep sockets 10 – 17mm for protruding bolts. Spark plug sockets for 14, 16, 18 and 21mm. Screwdriver bits with square drive for Allen screws 4 – 10mm and TX screws (20 – 45). Two extensions. Universal joint. Five angled Allen keys 1.25 – 1.5 – 2 – 2.5 and 3mm.

[See photo for full contents.](#)

NO 23 282

Including the robust and fine-toothed baton ratchet for powerful use.

Quick-release mechanism at the push of a button.

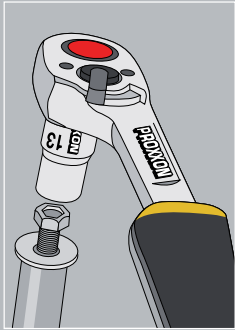

2 year guarantee

For full professional use!

Sockets and drive elements carry an additional **25 year guarantee** against faulty material and workmanship.

Asymmetrical shape improves view when attaching to nut or bolt head.

DIN
ISO



Perfect toothing and reliable reverse mechanism. Several of the 72 teeth engage simultaneously for transferring also high torques.



20-piece specialty socket set with deep sockets



With 1/4" square drive (6.3mm)

for torques under 25Nm: hexagonal sockets for 4 – 5 – 5.5 – 6 – 7 – 8 – 9 – 10 – 11 and 12mm.

With 1/2" square drive (12.5mm)

for torques over 25Nm: 13 – 14 – 15 – 16 – 17 – 18 – 19 – 20 – 21 – 22 and 24mm. All parts are matt chrome-plated and are clearly marked with sizes.

See photo for full contents.

NO 23 292

50-piece precision engineer's set with 1/4" baton ratchet



This set includes sockets from 4 – 13mm, deep sockets from 6 – 10mm for protruding bolts and screwdriver bits with square drive for slotted, Phillips, Allen and TX (with frontal hole) screws. It also has external TX sizes E4 – 10, universal joint, 2 extensions, screwdriver handle with square drive and 1.25 – 1.5 – 2 – 2.5 and 3mm angled Allen keys.

See photo for full contents.

NO 23 280

42-piece specialty set for TX and Allen screws



With 1/4" square drive (6.3mm)

(for tightening torques up to 25Nm): Screwdriver bits for Allen screws sizes 2 – 6mm and screwdriver bits TX8 – TX40 (with frontal hole) as well as external TX E4 to E10.

With 1/2" square drive (12.5mm)

(for tightening torques from 25 – 210Nm): Screwdriver bits for Allen screws sizes 7 – 14mm (short version, 55mm) and sizes 6 – 12mm (long version, 100mm), for TX screws sizes 45 – 60 (short version) and for external TX sizes E12 to E20. Includes 5 angled head Allen keys in 1.25 – 1.5 – 2 – 2.5 and 3mm.

See photo at left for full contents.

NO 23 290

NO 23 650: For 25 years this has been a classic among toolboxes world-wide.

Featuring first class assembly tools. Now in its 7th generation.

DIN
ISO

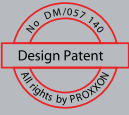

SlimLine-combination spanners from 6 – 19mm. Now 14 instead of 12 spanners (with sizes 16 and 18, new as per ISO for screws M 10 and M 12).

1/2"-sockets:
Now 14 instead of 10 sockets
(11, 16, 18 and 21mm have been added).

Ball-peen hammer (300g), with graphite handle for superior vibration damping, handy non-slip grip.

The selection of 16 and 21mm spark plug sockets was enlarged joining size 18mm, which has become increasingly important.

Reversible ratchet with release mechanism.



PROXXON design by Helmut Scholz: A high-quality POLYPROPYLENE tool case without frills. Treadable, shock-proof, fuel and acid resistant.

Automotive and universal tool set

Combination spanners from 6 – 19mm. 1/2" sockets from 8 – 24mm. Spark plug sockets 16 – 18 and 21mm. Automotive headlight tester with cord and crocodile clip (for car electrical systems). [See photo for full contents.](#) Each tool has its proper place – organized forever!

NO 23 650

KNIPEX

High quality combination pliers of CrV steel.

KNIPEX

Water pump pliers with box joint.



8-piece pocket Allen key (HX 1.5 – 8mm) and TX key (TX 9 – 40) sets.

Universal and oil siphoning pump AP 12. Perfect for effortless oil changes in 2 – 3 minutes.

Easily pumps motor, diesel and heating oil. Pump capacity approx. 250l/hr (with 1/2" feed hose). When changing oil with the wand, approx. 3l/min (40 °C oil temperature). 200cm long feed line with crocodile clips for battery terminals. Feed and supply side connecting pieces for 1/2" hoses. Includes a wand (approx. 800mm long, outer diameter 6mm) for the oil dipstick shaft, permanently fitted with a reinforced hose. A 1/2" transparent outlet hose, approx. 150cm long, is supplied. Housing of glass fibre reinforced POLYAMIDE, approx. 120 x 90 x 90mm. Approx. weight 1.4kg.

NO 25 262

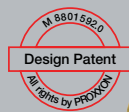

Note:

The wand fits all vehicles with a 6mm oil dipstick shaft.

The L-BOXX-system: Organisation and safety in storage and transport for professional craftsmen.

DIN
ISO

69 high quality tools placed ready to hand!

L-BOXX® -system L 102 (extremely flat!)



Store neatly, quickly and smoothly and transport safely. Compatible with numerous in-vehicle-equipment-systems of well-known brands. Outer dimensions: 445 x 358 x 118mm. Tool panel pouch and foam inlay made of high quality materials.

Craftman's universal tool set in proven L-BOXX-system

14 sockets 1/2" (12.5mm) 8 – 24mm, standard ratchet 1/2", universal joint, extensions 125 and 250mm, 4 deep sockets 10 – 19mm, 15 SlimLine combination spanners 6 – 21mm, MicroSpeeder ratchet spanners 10 x 13 and 17 x 19mm, 5 slot screwdrivers 3 – 6.5mm,

Phillips PH 1 and PH 2, voltage tester, pocket key sets HX and TX (9-piece each), KNIPEX combination pliers 180mm and KNIPEX water pump pliers 250mm, ball-peen hammer (300g) with graphite handle.
NO 23 660

1/4"
6.3mm

Ratchets, sockets and accessories for delicate projects.

All of chrome vanadium steel 31 CrV 3.

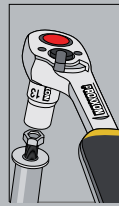

Baton ratchet 1/4". Our sturdy ratchet!

Fine tooth drive: Several of the 72 teeth engage simultaneously for transferring high torques. Reverse lever for ratcheting direction. Quick-release button for ejecting sockets. Head and shaft forged from one CrV steel billet. Double nickel plated with matt chrome plated finish. Grip of oil and acid-resistant TPR (thermoplastic rubber) with practical hole for hanging up.

NO 23 330

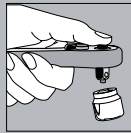

Ratchet 2000 1/4". Our extremely flat ratchet!

Precision ratchet drive for long service life and high torque transmission. Reverse lever for ratcheting direction. Quick-release button for releasing sockets instantly. With handy, soft-touch Dupont HYTREL grip and practical hole for hanging up.

NO 23 170



Standard ratchet 1/4". Proven many times over!

With reverse feature directly on ratchet mechanism. Several of the 52 teeth engage simultaneously for transferring extremely high torques. Quick-release button for ejecting sockets instantly. Head and shaft forged from one piece of CrV steel. Double nickel plated with matt chrome plated finish. Grip of oil and acid-resistant TPR (thermoplastic rubber) with practical hole for hanging up.

NO 23 092



Standard ratchet 1/4". With flexible head!

Head can be locked in 6 positions through 90° at the push of a button. Ideal where space is at a premium. Otherwise same as standard ratchet 1/4" (NO 23 092) described above.

NO 23 074

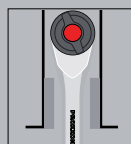

ROTARY-ratchet 1/4". With additional offset-screwdriver function.

The rotating grip design allows for pre-tensioning in abutment to one side. Then a few millimetres of standard ratcheting action is sufficient for loosening or tightening. Fine tooth drive (52 teeth) with convenient drive direction switch. Sockets are held firmly in place until the quick release button is activated.

NO 23 082

MICRO ratchets for tricky work and where space is tight! For screwing in the engine compartment, under the dashboard or on the airbag, for working on the air conditioning system, inside the car body, the sun roof etc.

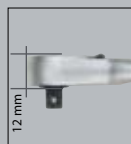

MICRO compact ratchet with 1/4" square drive.

With extremely slim head (23 x 12mm). Fine-toothing: Many of the 72 teeth engage simultaneously for transferring extremely high torques. Reverse lever for ratcheting direction. Release mechanism: unlocking the sockets at the push of a button. Forged from CrV steel, double nickel plated with matt chrome plated finish. Grip of oil- and acid-resistant TPR (Thermoplastic Rubber). Total length 120mm. With practical hole for hanging up.

NO 23 160

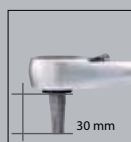

MICRO bit ratchet with 1/4" hexagonal adapter

For 1/4" standard bits. With magnetic insert. Distance between reverse lever and bit end only 30mm. Technology and application identical to the 1/4" MICRO compact ratchet described above.





NO 23 158



1/4"
6.3mm

Sockets and accessories for delicate projects.

All of chrome vanadium steel 31 CrV 3.

		Size	Part No
	1/4" sliding T-bar	100mm	23 704
	1/4" extension	50mm 100mm 150mm	23 707 23 708 23 705
	1/4" flexible extension	150mm	23 706
	1/4" universal joint		23 709
	1/4" magnetic holder for hexagonal bits with male and female HX shafts. Ideal for working with electric screwdrivers and drills.		23 703
	1/4" drill adapter for 1/4"-sockets		23 700
	1/4" drive screwdriver handle with 1/4" connector at rear end, 140mm long	14mm	23 702
	1/4" adapter for hexagonal bits (DIN 3126) female square to female hexagon ①		23 780
	1/4" adapter 1/4" female square to 3/8" male square ②		23 782
	1/4" adapter with 1/4" male square to 1/4" male hexagon. ③		23 701
	1/4" sockets Made of CrV steel. Total length 25mm.	4mm 4.5mm 5mm 5.5mm 6mm 6.5mm 7mm 8mm 9mm 10mm 11mm 12mm 13mm 14mm	23 710 23 711 23 712 23 713 23 714 23 715 23 716 23 718 23 720 23 722 23 724 23 726 23 728 23 729



1/4" deep sockets
 For long protruding bolts.
 Made of CrV steel. Total length 50mm.

Size	Part No
4mm	23 767
5mm	23 768
5.5mm	23 769
6mm	23 770
7mm	23 772
8mm	23 774
9mm	23 776
10mm	23 778
11mm	23 777
12mm	23 775
13mm	23 779
14mm	23 773



1/4" Allen socket bits, 33mm
 Head made of chrome-silicon-manganese-molybdenum steel.
 Socket CrV steel.

HX 2mm	23 744
HX 2.5mm	23 746
HX 3mm	23 743
HX 4mm	23 745
HX 5mm	23 747
HX 6mm	23 749
HX 8mm	23 751



1/4" female TX (TTX) sockets
 Made of CrV steel. Total length 25mm.

E 4	23 788
E 5	23 790
E 6	23 792
E 7	23 793
E 8	23 794
E 10	23 796



1/4" TTX screwdriver bits, 33mm (with frontal hole)
 Head made of chrome-silicon-manganese-molybdenum steel. Socket CrV steel.

TTX 5	23 755
TTX 6	23 752
TTX 8	23 753
TTX 10	23 754
TTX 15	23 756
TTX 20	23 758
TTX 25	23 760
TTX 27	23 761
TTX 30	23 762
TTX 40	23 764



1/4" flat-blade screwdriver bits, 33mm
 Made of chrome-silicon-manganese-molybdenum steel. Socket CrV steel.

FD 4mm	23 737
FD 5.5mm	23 739
FD 7mm	23 741
FD 8mm	23 742

1/4" Phillips screwdriver bits, 33mm
 Made of chrome-silicon-manganese-molybdenum steel. Socket CrV steel.

PH 1	23 730
PH 2	23 731
PH 3	23 732



1/4" Pozidrive screwdriver bits, 33mm
 Made of chrome-silicon-manganese-molybdenum steel. Socket CrV steel.

PZ 1	23 733
PZ 2	23 735

3/8"
10mm

Ratchets, sockets and accessories, handy and compact

for every user! 31 CrV 3 chrome-vanadium steel.

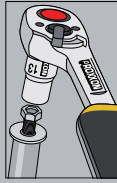

Baton ratchet 3/8". Our sturdy ratchet!

Fine tooth drive: Several of the 72 teeth engage simultaneously for transferring maximum torque. Reverse lever for ratcheting direction. Quick-release button for releasing sockets instantly. Head and shaft forged from one piece of CrV steel. Double nickel-plated with matt chrome-plated finish. Grip of oil and acid-resistant TPR (thermoplastic rubber) with practical hole for hanging up.

NO 23 332

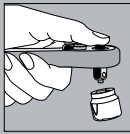

Ratchet 2000 3/8". Our extremely flexible ratchet!

Precision ratchet drive with 44 teeth for long service life and high torque. Reverse lever for ratcheting direction. Quick-release button for releasing sockets instantly. With handy, soft-touch Dupont HYTREL grip and practical hole for hanging up.

NO 23 180



Standard ratchet 3/8". Proven many times over!

With reverse feature directly on ratchet mechanism. Several of the 52 teeth engage simultaneously for transferring extremely high torque. Quick-release button for releasing sockets instantly. Head and shaft forged from one piece of CrV steel. Double nickel-plated with matt chrome-plated finish. Grip of oil and acid-resistant TPR (thermoplastic rubber) with practical hole for hanging up.

NO 23 094

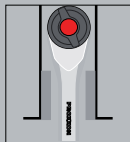

ROTARY-ratchet 3/8". With additional offset-screwdriver function.

The rotating grip design allows for pre-tensioning in abutment to one side. Then a few millimetres of standard ratcheting action is sufficient for loosening or tightening. Fine tooth drive (52 teeth) with convenient drive direction switch. Sockets are held firmly in place until the quick release button is activated.

NO 23 083



3/8" extension with slide

Adapter to 3/8" male square and 1/2" female square.

Size Part No

200mm 23 558



3/8" extension

75mm 23 554
150mm 23 556



3/8" universal joint

23 560



3/8" adapter

3/8" female to 1/4" male square (slide for 1/4" extension).

23 564



3/8" adapter

3/8" female square drive to male 1/2" drive (slide for 1/2" extension).

23 566



3/8" drill adapter

for 3/8"-sockets

23 562



3/8" spark plug socket

With TPR (thermoplastic rubber) insert for holding spark plugs. Length 64mm.

16mm 23 550
18mm 23 551

As above, length 70mm

19mm 23 541
21mm 23 552



3/8" spark plug socket

HX and double HX (BI-HX) spark plugs. Slim design (Ø 20mm). With TPR (thermoplastic rubber) insert for holding spark plugs. Length 64mm.

14mm 23 553



3/8" sockets
Made of CrV steel.

Size	Part No
6mm	23 500
7mm	23 502
8mm	23 504
9mm	23 506
10mm	23 508
11mm	23 510
12mm	23 512
13mm	23 514
14mm	23 516
15mm	23 518
16mm	23 520
17mm	23 522
18mm	23 523
19mm	23 524
21mm	23 526
22mm	23 528
24mm	23 530



3/8" deep sockets
for protruding bolts.
Made of CrV steel.
Total length 46mm.

8mm	23 532
9mm	23 534
10mm	23 536
11mm	23 538
12mm	23 540
13mm	23 542
14mm	23 543

As above, total length 64mm.

15mm	23 544
17mm	23 546
18mm	23 548
19mm	23 549
22mm	23 545
24mm	23 547



3/8" Allen socket bits, 50mm
Allen key made of chrome-silicon-
manganese-molybdenum steel.
Socket CrV steel.

HX 4mm	23 575
HX 5mm	23 576
HX 6mm	23 578
HX 7mm	23 579
HX 8mm	23 580
HX 9mm	23 577
HX 10mm	23 581
HX 11mm	23 573



3/8" external TX socket
Made of CrV steel.

E 6	23 612
E 7	23 613
E 8	23 614
E 10	23 616
E 12	23 618
E 14	23 620
E 18	23 624



3/8" TX socket bits, 50mm
Head made of chrome-silicon-manganese-
molybdenum steel. Socket CrV steel.

TX 10	23 583
TX 15	23 582
TX 20	23 584
TX 25	23 585
TX 27	23 586
TX 30	23 587
TX 40	23 588
TX 45	23 589
TX 50	23 590



3/8" flat-blade screwdriver bits, 50mm
Bit made of chrome-silicon-manganese-
molybdenum steel. Socket CrV steel.

FD 4mm	23 591
FD 5.5mm	23 592
FD 8mm	23 593

3/8" Phillips screwdriver bits, 50mm
Bit made of chrome-silicon-manganese-
molybdenum steel. Socket CrV steel.

PH 1	23 594
PH 2	23 595
PH 3	23 596



3/8" spline socket bits, 50mm
for XZN bolts. Bit made of chrome-silicon-
manganese-molybdenum steel. Socket CrV steel.

VZ 5	23 628
VZ 6	23 629
VZ 8	23 631
VZ 10	23 633

1/2"
12.5mm

Ratchets, sockets and accessories for the most

demanding situations. 31 CrV 3 chrome-vanadium steel.

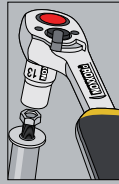

Baton ratchet 1/2". Our sturdy ratchet!

Fine tooth drive: Several of the 72 teeth engage simultaneously for transferring maximum torque. Reverse lever for ratcheting direction. Quick-release button for releasing sockets instantly. Head and shaft forged from one piece of CrV steel. Double nickel-plated with matt chrome-plated finish. Grip of oil and acid-resistant TPR (thermoplastic rubber) with practical hole for hanging up.

NO 23 334

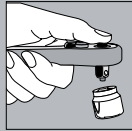

Ratchet 2000 1/2". Our extremely flexible ratchet!

Precision ratchet drive with 44 teeth for long service life and high torque transmission. Reverse lever for ratcheting direction. Quick-release button for releasing sockets instantly. With handy, soft-touch Dupont HYTREL grip and practical hole for hanging up.

NO 23 190

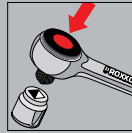

Standard ratchet 1/2". Proven many times over!

With reverse feature directly on ratchet mechanism. Several of the 52 teeth engage simultaneously for transferring extremely high torque. Quick-release button for releasing sockets instantly. Head and shaft forged from one piece of CrV steel. Double nickel-plated with matt chrome-plated finish. Grip of oil and acid-resistant TPR (thermoplastic rubber) with practical hole for hanging up.

NO 23 096

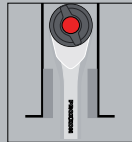

ROTARY-ratchet 1/2". With additional offset-screwdriver function.

The rotating grip design allows for pre-tensioning in abutment to one side. Then a few millimetres of standard ratcheting action is sufficient for loosening or tightening. Fine tooth drive (52 teeth) with convenient drive direction switch. Sockets are held firmly in place until the quick release button is activated.

NO 23 084



Extra long lever with universal joint and ratchet mechanism

For effortless loosening of tightly locked screws. Robust ratchet mechanism (60 teeth) with knurled ring offering reverse operation. Grip made of oil and acid resistant TPR (Thermoplastic Rubber).

NO 23 090 Total length 43cm



1/2" extension with slide
With adapter from 1/2" male to 3/8" female.

Size	Part No
250mm	23 457



Size	Part No
64mm	23 452
125mm	23 454
250mm	23 456



1/2" female to 3/8" male square drive
(sliding part for 3/8" extension) 23 458



1/2" universal joint 23 450



1/2" drill adapter
for 1/2" sockets 23 460



1/2" spark plug sockets
With TPR (thermoplastic rubber) insert for holding spark plugs. Length 65mm. 16mm 23 442

Size	Part No
18mm	23 443
19mm	23 445
21mm	23 444



1/2" spark plug sockets
With TPR (thermoplastic rubber) insert for holding spark plugs. Length 65mm.

16mm 23 392

As above, length 70mm

18mm 23 394
19mm 23 395
21mm 23 396



1/2" sockets
With reduced drive and diameter (19mm and over).
Made of CrV steel.

8mm 23 400
9mm 23 402
10mm 23 404
11mm 23 406
12mm 23 408
13mm 23 410
14mm 23 412
15mm 23 414
16mm 23 415
17mm 23 416
18mm 23 417
19mm 23 418
20mm 23 419
21mm 23 420
22mm 23 422
23mm 23 423
24mm 23 424
27mm 23 426
30mm 23 428
32mm 23 430
34mm 23 431
36mm 23 429



1/2" deep sockets
For protruding bolts.
Made of CrV steel. Total length 79mm.

10mm 23 355
11mm 23 356
12mm 23 357
13mm 23 358
14mm 23 359
15mm 23 360
16mm 23 361
17mm 23 362
18mm 23 363
19mm 23 364
21mm 23 365
22mm 23 366
24mm 23 367



1/2" flat-blade screwdriver bits, 55mm
Chrome-silicon-manganese-molybdenum steel.
CrV steel socket.

FD 8mm 23 462
FD 10mm 23 464

1/2" Phillips screwdriver bits, 55mm
Chrome-silicon-manganese-molybdenum steel.
CrV steel socket.

PH 2 23 470
PH 3 23 472
PH 4 23 474

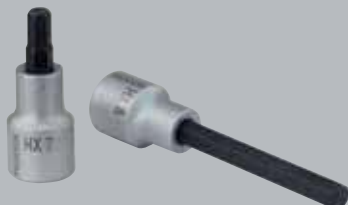

1/2" Allen socket bits, 55mm
Allen key made of chrome-silicon-manganese-molybdenum steel.
Socket CrV steel

HX 5mm 23 476
HX 6mm 23 477
HX 7mm 23 478
HX 8mm 23 479
HX 9mm 23 463
HX 10mm 23 480
HX 11mm 23 465
HX 12mm 23 481
HX 14mm 23 482

1/2" Allen socket bits, 100mm
Allen key made of chrome-silicon-manganese-molybdenum steel.
Socket CrV steel.

HX 5mm 23 484
HX 6mm 23 475
HX 7mm 23 485
HX 8mm 23 486
HX 9mm 23 466
HX 10mm 23 487
HX 11mm 23 467
HX 12mm 23 483
HX 14mm 23 468

1/2"
12.5mm



1/2" external TX socket
Made of CrV steel.

Size	Part No
E 10	23 380
E 12	23 382
E 14	23 384
E 18	23 388
E 20	23 390

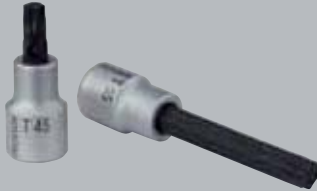

1/2" TX socket bits, 55mm
Head made of chrome-silicon-manganese-molybdenum steel. Socket CrV steel.

TX 20	23 488
TX 25	23 489
TX 27	23 490
TX 30	23 491
TX 40	23 492
TX 45	23 493
TX 50	23 494
TX 55	23 446
TX 60	23 447
TX 70	23 448

1/2" TX socket bits, 100mm
Head made of chrome-silicon-manganese-molybdenum steel. Socket CrV steel.

TX 40	23 495
TX 45	23 496
TX 50	23 497
TX 55	23 498
TX 60	23 499



1/2" spline socket bits, 55mm
for XZN bolts. Bit made of chrome-silicon-manganese-molybdenum steel. Socket CrV steel.

VZ 5	23 318
VZ 6	23 319
VZ 8	23 321
VZ 10	23 323
VZ 12	23 325
VZ 14	23 327

1/2" spline socket bits, 100mm
for XZN bolts. Bit made of chrome-silicon-manganese-molybdenum steel. Socket CrV steel.

VZ 6	23 370
VZ 8	23 371
VZ 9	23 376
VZ 10	23 372
VZ 12	23 373
VZ 14	23 374



1/2" sockets for XZN-screws, 12-pt
Made of CrV steel.

9mm	23 304
10mm	23 305
12mm	23 307
18mm	23 311
19mm	23 312
21mm	23 314

3/4"
19mm

Socket set with 3/4 square drive.

14-piece socket set with 3/4" square drive.
For lorries, tractors and other machinery.

10 sockets from 22 – 50mm. 520mm ratchet (72 teeth) with quick-release button for releasing sockets instantly. Sliding T-bar (500mm). Each one extension of 200mm and 400mm.

NO 23 300



Workshop special sets for long bolts and screws. With forged,

short tubular hexagon box spanners and externally gripping ratchet.

**2 year
guarantee**

For full professional use!



14-piece special set 13 to 27mm

With reversible ratchet, TPR (thermoplastic rubber) grip, 55mm extension (open construction as well) and adapter with 1/2" square (12.5mm). In robust steel box (powder coated) with strong plastic tray.

NO 23 604

13-piece special set 5.5 to 14mm

With reversible ratchet, TPR (thermoplastic rubber) grip, 55mm extension (open construction as well) and adapter with 1/4" (6.3mm) square. In robust steel box (powder coated) with strong plastic tray.

NO 23 602

Adjustable wrenches forged from CrV steel. According to DIN 3117 / ISO 6787.

Extra-long version with soft-finish skin-friendly handle made of oil and acid resistant TPR (thermoplastic rubber) with hanging hole. Slim head with ground jaws. Accurate control of flexible jaw with smooth-running adjustment via knurled screw. Easy to read millimetre scale for defining size across flats and measuring work pieces.

jaw width

NO 23 990	RG 200	24.5mm
NO 23 992	RG 250	29mm
NO 23 994	RG 300	34mm



IMPACT socket sets for wheel nuts. Sockets with plastic cover and plastic stop insert prevent aluminium wheel rims from damage. Now also available in extra long version (130mm).

For use with pneumatic screwdrivers 1/2". Made of high alloy special steel for superior wear resistance and a maximum torque of 500Nm. One piece each 17 – 19 and 21mm in sturdy steel box (powder coated).

NO 23 938	standard version,	85mm
NO 23 970	extra long version,	130mm

IMPACT sockets, individually. Standard length: 85mm.

NO 23 962	Size 17
NO 23 964	Size 19
NO 23 966	Size 21

IMPACT sockets, individually. Extra long version: 130mm.

NO 23 972	Size 17
NO 23 974	Size 19
NO 23 976	Size 21



MicroClick torque wrenches. Precision tools with high accuracy (tolerance of +/- 3%)

Including test certificate.

PROXXON

INDUSTRIAL

**Ratchet mechanism with reversing lever for clockwise and anticlockwise rotation.
Automatic quick release: Clearly audible and palpable click signal when selected torque**



Clearly legible analogue display for simple pre-selection of the desired torque.

Ergonomically shaped handle allows for automatically gripping it in a centric position. Important for obtaining an exact release torque.

Additional micro-scale for fine adjustment.

Simple pre-setting of the torque by turning the knurled ring at the end of the handle, fixing it by sliding it into position.



Note:
IMPACT sockets for wheel nuts are featured on page 19!



Sturdy, oval steel shaft with rust-protective finish: double nickel and subsequent matt-finished chrome-plating.



MicroClick MC 320. For 60 – 320Nm.

With 1/2" square drive (12.5mm). Total length 610mm.
Otherwise as described above.
NO 23 354

MicroClick MC 200. For 40 – 200Nm.

With 1/2" square drive (12.5mm). Total length 530mm.
Otherwise as described above.
NO 23 353

MicroClick MC 100. For 20 – 100Nm.

With 3/8" square drive (10mm). Total length 430mm.
Particularly suitable for motorcycles. Otherwise as described above.
NO 23 351

MicroClick MC 60. For 12 – 60Nm.

With 3/8" square drive (10mm). Total length 370mm.
Otherwise as described above.
NO 23 350

MicroClick MC 30. For 6 – 30Nm.

With 1/4" square drive (6.3mm). Total length 335mm.
Otherwise as described above.
NO 23 349

according to ISO 6789). Calibrated and inspected piece by piece.

is reached.

2 year guarantee

For full professional use!

Practical release mechanism: the socket is securely fixed and automatically released at the push of the button.

Reverse lever for clockwise and anticlockwise rotation.

MC 100

MC 60

MC 30

Piece by piece calibration and final inspection. With permanent laser-marked serial number identifying the product.



Note:
MicroClick torque screwdrivers MC 2 (0.4 to 2Nm), MC 5 (1 to 5Nm) und MC 10 (2 to 10Nm) as well as MicroClick torque wrench MC 15 (3 to 15Nm) are featured on pages 22/23.



MicroClick torque wrenches are precision tools. They are packaged in a sturdy and practical plastic storage box.

mm	HX	INHX	FM-TX	M-TX	XZN	Nm ¹⁾
M 1,6	SW 3,2	HX 1,5	TX 5	-	-	0,2
M 2	SW 4	HX 1,5	TX 6	-	-	0,35
M 2,5	SW 5	HX 2	TX 7; 8	-	-	0,8
M 3	SW 5,5	HX 2,5	TX 9; 10	E 4	-	1,3
M 3,5	SW 6	HX 2,5	TX 15	E 4	-	2
M 4	SW 7	HX 3	TX 20	E 5; 6	-	2,9
M 5	SW 8	HX 4	TX 25; 27	E 6; 8	-	6
M 6	SW 10	HX 5	TX 27; 30	E 8; 10	VZ 5	10,2
M 7	SW 11	HX 5	TX 40	E 8; 10	VZ 5	16
M 8	SW 13	HX 6	TX 45	E 10; 12	VZ 6	25
M 10	SW 16; 17	HX 8	TX 45; 50	E 12; 14	VZ 8	50
M 12	SW 18; 19	HX 10	TX 55	E 14; 18	VZ 10	86
M 14	SW 21; 22	HX 12	TX 60	E 18; 20	VZ 12	138
M 16	SW 24	HX 14	TX 70	E 20	VZ 14	215
M 18	SW 27	HX 14	TX 80	E 24	-	296
M 20	SW 30	HX 17	TX 90	E 24	-	420
M 22	SW 32; 34	-	-	-	-	573
M 24	SW 36	HX 19	-	-	-	725

1) Schraubenqualität 8.8; Gewindereibzahl $\mu=0,14$
PROXXON S.A., LU-6868 Wecker © by PROXXON

Tightening torques for bolt shanks with standard metric threads (DIN 13, Part 13) and head contact dimensions (DIN 912, 931, 934). The coefficient of friction was determined using an untreated and unplated bolt (ungreased, lightly oiled).

MicroClick torque wrench MC 200-Multi. For 40 – 200Nm. Ratcheting head reversible for lefthand-threads.



Allows for torque controlled tightening of screws and sleeves on pipe connections, hydraulic systems, pneumatic pipelines, threaded rods. A problem solver when space does not allow for the tool to be fitted from the top. For lateral access and working when space is at a premium.

10 plug-on tools with square joint (14 x 18mm) to safely lock into position via spring bolt: 9 open-end spanners, forged of CrV steel, available in sizes 13 – 14 – 15 – 17 – 19 – 22 – 24 – 27 and 30mm. The ratcheting head with 1/2" (12.5mm) square drive (reversible for lefthand-threads) turns the MicroClick 200-Multi into a normal torque wrench for sockets.

Configuration and technology otherwise like MicroClick MC 200 and series (see left).

NO 23 342

For safety and the accurate tightening torque: MicroClick precision tools.

**2 year
guarantee**

For full professional use!

MicroClick torque wrench MC 15 For 3 to 15Nm.

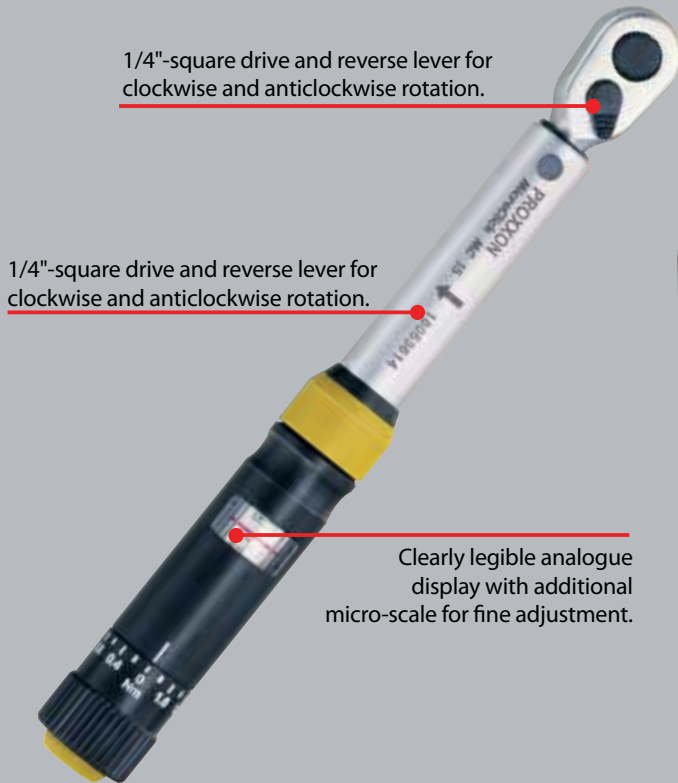

1/4"-square drive and reverse lever for clockwise and anticlockwise rotation.

1/4"-square drive and reverse lever for clockwise and anticlockwise rotation.

Clearly legible analogue display with additional micro-scale for fine adjustment.

Automatic quick-release when tightening screws: Clearly audible and palpable click signal when the selected torque is reached. Pre-setting of the torque by turning the knurled ring at the end of the handle, fixing it by sliding it into position. Clearly legible analogue scale display and additional micro scale for fine adjustment. Scale ring with 0.4Nm graduation. 1/4" square drive (6.3mm) with adapter for use of 1/4" standard screwdriver bits. Reverse lever for clockwise and anticlockwise rotation. Accuracy +/- 3%. Total length 195mm.

NO 23 345



The depicted torque screwdrivers and torque wrenches are precision tools. They come in a practical storage box for optimum protection.



3/4"
19mm

MicroClick torque wrench MC 500

For 100 – 500Nm. Also suited for the 3/4" sockets described on the right.



For repairs on small trucks, transporters and tractors. With 3/4" square drive (19mm). Ratchet mechanism with reversing lever for clockwise and anticlockwise rotation. Sturdy steel shaft with rust-protective finish: double nickel and subsequent matt-finished chrome-plating. Piece by piece calibration and final inspection (including test certificate). Tolerance according to ISO 6789: +/- 3%.

Clearly legible analogue display with additional micro-scale for fine adjustment. Total length 820mm. Packaged in a practical plastic storage box.

NO 23 340

Calibrated piece by piece. Including test certificate.

MicroClick torque screwdriver MC 5 For 1 – 5Nm.



Automatic quick-release when tightening screws: Clearly audible and palpable click signal when the selected torque is reached. Pre-setting of the torque by turning the knurled ring at the end of the handle, fixing it by sliding it into position. Clearly legible scale display. Additional micro scale for fine adjustment: 1 rotation = 1Nm. Scale ring with 0.10Nm graduation. With 1/4" square drive (6.3mm) for holding sockets and self-locking adapter with spring sleeve for holding 1/4" (6.3mm) standard bits in a form fitting manner. Accuracy +/- 6%. Total length 165mm.

NO 23 347



MicroClick torque screwdriver MC 2 For 0.4 – 2Nm.



Automatic quick-release when tightening screws: Clearly audible and palpable click signal when the selected torque is reached. Pre-setting of the torque by turning the knurled ring at the end of the handle (lockable). Clearly legible scale display. 50mm long slim shaft with magnetic holder for 1/4" (6.3mm) standard bits. Includes adapter with 1/4" male hexagon drive to 1/4" male square drive for sockets. Accuracy +/- 6%. Total length 170mm. Weight 135g.

NO 23 343



Note:

A well-shaped ergonomic screwdriver handle allows for torques from 6 to 8Nm just by manual operation. For higher torques, the **MC 10** has a 1/4" square connector on the rear end for fitting a lever (T-handle, ratchet).



Self-locking adapter with spring sleeve for 1/4" standard bits is included.



MicroClick torque screwdriver MC 10 For 2 – 10Nm.

Fine adjustment: 1 rotation = 2Nm. Scale ring with 0.2Nm graduation. Rear end with 1/4" connector for mounting a T-handle (included in the scope of delivery). Otherwise identical with the MC 5 described on the left.

NO 23 348

Socket set with 3/4" (19mm) square drive.

14-piece socket set with 3/4" square drive. For lorries, tractors and other machinery.

10 sockets from 22 – 50mm. 520mm ratchet (72 teeth) with quick-release button for releasing sockets instantly. Sliding T-bar (500mm). Each one extension of 200mm and 400mm.

NO 23 300



MicroSpeeder with ratchet mechanism on the ring end.

No swapping over: a real time saver! Extra long design.

PROXXON

INDUSTRIAL

2 year
guarantee

For full professional use!

Where old generation spanners cannot be repositioned the Speeder's ratchet function takes over.

The 72-teeth inner ring gear made of special high alloy steel allows ratcheting even when the spanner can only be moved through 5°. However, the torque transmission capacity far exceeds the DIN/ISO standards. CrV steel shaft with optimum surface protection: double nickel-plating and single matt-finished chrome-plating. Spanner sizes easy to read due to laser marking!



A very slim head provides shelter to the fully encapsulated drive.



Compact design allows for minimal outer dimensions (A + B).



MicroSpeeder in standard version (straight, slender design without reverse lever).



With ratchet mechanism on the ring end. No swapping over: a real time saver! Ideal for inserting into tight spaces. For removing engines, on automatic transmissions or rear axles, etc.

MicroSpeeder in standard version, individually

NO 23 257	Size 8
NO 23 258	Size 9
NO 23 259	Size 10
NO 23 260	Size 11
NO 23 261	Size 12
NO 23 262	Size 13
NO 23 263	Size 14
NO 23 264	Size 15
NO 23 265	Size 16
NO 23 266	Size 17
NO 23 267	Size 18
NO 23 268	Size 19
NO 23 270	Size 21
NO 23 271	Size 22
NO 23 273	Size 24

7-piece MicroSpeeder set in straight, slim design

One each 8 – 10 – 13 – 16 – 17 – 18 and 19mm in extra long design as featured. In a sturdy powder coated steel box.
NO 23 275

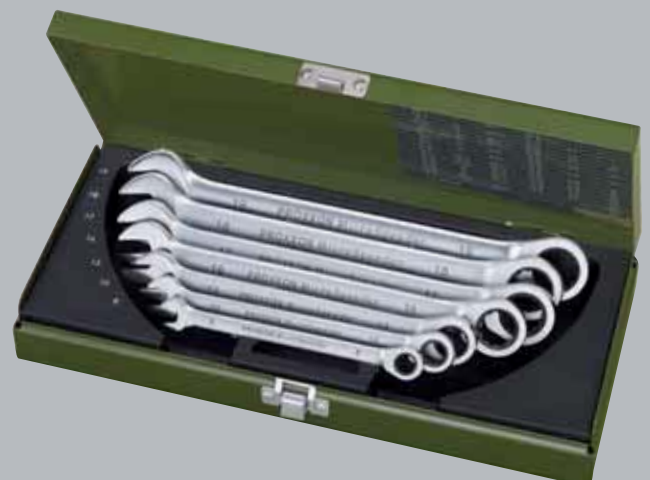

Straight design without reversing lever. The spanner is simply swapped over.

**2 year
guarantee**

For full professional use!



10-piece MicroSpeeder set in foldable plastic holder. 8 – 19mm.



With ratchet mechanism and reverse lever on the ring end for clockwise and anticlockwise rotation. No swapping over: a real time saver. Ideally suited for working on flat surfaces due to its 15° offset ring side. Practical foldable holder offering a clearly marked place for storage of each spanner. The ideal companion for construction site work. Holder also provides holes for wall-mounting in the workshop. With clearly readable sizes. Organised forever!

One each in extra long design, sizes 8 – 10 – 11 – 12 – 13 – 14 – 16 – 17 – 18 and 19mm.

NO 23 126



MicroSpeeder with reverse lever and 15° offset ring side.



As the 15° offset ring makes turning over of the spanner impossible, the spanner offers a reverse lever. Its design makes it ideally suited for working on flat surfaces.

MicroSpeeder with reverse lever, individually

- NO 23 130** Size 8
- NO 23 131** Size 9
- NO 23 132** Size 10
- NO 23 133** Size 11
- NO 23 134** Size 12
- NO 23 135** Size 13
- NO 23 136** Size 14
- NO 23 137** Size 15
- NO 23 138** Size 16
- NO 23 139** Size 17
- NO 23 140** Size 18
- NO 23 141** Size 19
- NO 23 143** Size 21
- NO 23 144** Size 22
- NO 23 146** Size 24

7-piece MicroSpeeder set with reverse lever

One each 8 – 10 – 13 – 16 – 17 – 18 and 19mm in a sturdy powder coated steel box.

NO 23 124



With its 15° offset ring side, it is ideally suited for working on flat surfaces.

MicroSpeeder ratcheting function. No swapping over of the spanner:

a real time saver. Extra long design.

Double ring MicroSpeeder in straight, slender design. Ideal for inserting into tight spaces.



Straight design without reversing lever. The spanner is simply swapped over.

Often used for demounting engines, working on automatic transmissions, rear axles, etc. Ratcheting function with 72-teeth inner gear ring, made of high alloy special steel allowing ratcheting even when the spanner can only be moved through 5°. Shaft of CrV steel with optimum surface protection: double nickel-plating and single matt-finished chrome-plating. With durable laser marking and easy-to-read sizes.

NO 23 241 Size 8 x 9
NO 23 243 Size 10 x 11
NO 23 244 Size 10 x 13
NO 23 246 Size 12 x 13

NO 23 247 Size 14 x 15
NO 23 249 Size 16 x 18
NO 23 250 Size 17 x 19
NO 23 252 Size 22 x 24

2 year guarantee

For full professional use!

Hinged MicroSpeeder with self positioning ring head, tilting through 90° to both sides.



The self positioning action of the hinged ring side substantially reduces work load, while its flexibility and durability remain unmatched. The self positioning action of the ring is ideal for tight locations.

Hinged MicroSpeeder, individually

NO 23 045 Size 8mm
NO 23 046 Size 9mm
NO 23 047 Size 10mm
NO 23 048 Size 11mm
NO 23 049 Size 12mm
NO 23 050 Size 13mm
NO 23 051 Size 14mm
NO 23 052 Size 15mm
NO 23 053 Size 16mm
NO 23 054 Size 17mm
NO 23 055 Size 18mm
NO 23 056 Size 19mm
NO 23 058 Size 21mm
NO 23 059 Size 22mm
NO 23 061 Size 24mm

7-piece Hinged MicroSpeeder set

One each 8, 10, 13, 16, 17, 18 and 19mm of the long version, in a sturdy powder coated steel box.

NO 23 068



Inversible joint:
 Unbeatable in tight places!

Quadruple MicroSpeeder. Just one tool for the four most important automotive fasteners: 10 – 13 – 17 – 19mm.

PROXXON

INDUSTRIAL



Ratcheting function with 72-teeth inner gear ring, made of high alloy special steel allowing ratcheting even when the spanner can only be moved through 5°. With reverse lever for clockwise and anticlockwise rotation. Shaft of CrV steel with optimum surface protection: double nickel-plating and single matt-finished chrome-plating. With durable laser marking and easy-to-read sizes. Total length 210mm.
NO 23 236

2 year guarantee

For full professional use!

Note:

The Quadruple MicroSpeeder is somewhat bulkier when compared to using double ring MicroSpeeders 10 x 13 or 17 x 19mm. Also it cannot be passed through for sizes 13 and 19. But you have just one single tool in your pocket!

Standard Speeder ratchet spanners. With reverse lever. Easy, handy and especially practical for installation work.

6-piece Speeder ratchet spanner set

Spanners 6 – 19mm. One each in sizes 6 x 7, 8 x 9, 10 x 11, 12 x 13, 14 x 15 and 17 x 19mm. Reliable ratchet mechanism with inner ring gear of CrV steel (reversible). Packed in sturdy steel box (powder coated) with flap clasp. Tray with practical recess area for storage of small parts (the depicted nuts are not included in the scope of delivery).

NO 23 231

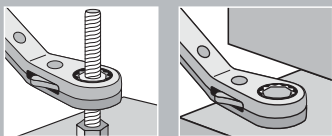

**DIN
ISO**

Speeder ratchet spanners, individually

NO 23 201	Size 6 x 7	NO 23 211	Size 14 x 15
NO 23 204	Size 8 x 9	NO 23 214	Size 16 x 18
NO 23 205	Size 10 x 11	NO 23 215	Size 17 x 19
NO 23 207	Size 10 x 13	NO 23 216	Size 19 x 21
NO 23 209	Size 12 x 13		

SlimLine spanners. Hands-on tools. CrV steel drop forged, carefully hardened and pla



10 year guarantee

For full professional use!



DIN ISO

- Optimal surface protection by means of double nickel-plating and single chrome-plating. With easy to hold, smooth finish.
- With durable laser inscribed and clearly readable sizes in mm.
- Polished heads: slim and thin walled. Torque characteristics still exceed DIN/ISO requirements.
- Dimensional tolerances are better than those required by DIN/ISO. Each piece is calibrated and checked.

8-piece SlimLine open-end spanner set, including holder. To DIN 3110 and ISO 3318.

Includes 6 x 7, 8 x 9, 10 x 11, 12 x 13, 14 x 15, 16 x 17, 18 x 19 and 20 x 22mm. Supplied with a plastic holder with slot for each spanner and holes for attaching to a wall. All spanners clearly labelled to make them easy to find.

NO 23 800 set



Each spanner has a clearly marked place for storage. The plastic holder also offers holes to allow for fixing it to a wall.

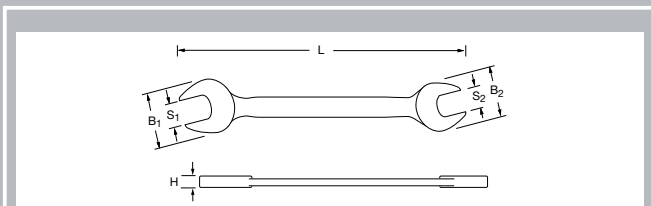

PROXXON INDUSTRIAL		SlimLine open-end spanners, individually				
	S ₁ x S ₂	B ₁	B ₂	L	H	
23 828	5 x 5.5 mm	13	14	111	3	
23 830	6 x 7 mm	16	18	123	3.4	
23 832	8 x 9 mm	20	22	140	3.5	
23 834	10 x 11 mm	24	26	157	4.5	
23 836	12 x 13 mm	28	29	173	4.7	
23 838	10 x 13 mm	24	29	174	4.7	
23 840	14 x 15 mm	32	34	190	5.5	
23 842	16 x 17 mm	36	38	205	6	
23 846	18 x 19 mm	38	42	220	6.5	
23 848	17 x 19 mm	38	42	220	6.5	
23 850	20 x 22 mm	43	46	235	7.5	
23 852	21 x 23 mm	45	48	248	7.5	
23 856	24 x 27 mm	49	55	268	8.5	
23 860	30 x 32 mm	59	64	302	9.5	
23 864	34 x 36 mm	65	79	320	10	
23 866	41 x 46 mm	86	95	415	15	



12-piece SlimLine ring-combination spanner set. Including holder. To DIN 3113 and ISO 3318 (ring head offset 15°).

Sizes 6 – 7 – 8 – 9 – 10 – 11 – 12 – 13 – 14 – 15 – 17 and 19mm. Each spanner has a clearly marked place for storage. The plastic holder also offers fixing holes.

NO 23 820 set

15-piece SlimLine combination spanner set. With the new ISO sizes 16, 18 and 21mm. Otherwise as described on the left.

Sizes 6 – 7 – 8 – 9 – 10 – 11 – 12 – 13 – 14 – 15 – 16 – 17 – 18 – 19 and 21mm.

NO 23 821 set

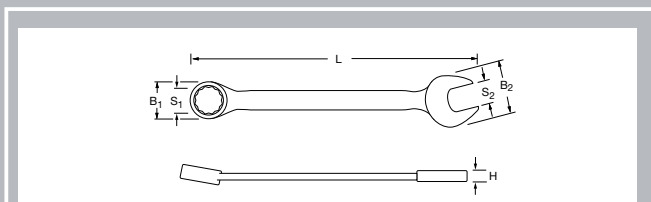

PROXXON INDUSTRIAL SlimLine combination spanners, individually

	S ₁	B ₁	B ₂	L	H
23 905	5,5 mm	9	14	93	3
23 906	6 mm	10	16	100	3.4
23 907	7 mm	12	18	110	3.4
23 908	8 mm	13	20	120	3.5
23 909	9 mm	15	22	130	3.5
23 910	10 mm	16	24	140	4.5
23 911	11 mm	17	26	150	4.5
23 912	12 mm	19	28	160	4.7
23 913	13 mm	20	29	170	4.7
23 914	14 mm	22	32	180	5.5
23 915	15 mm	24	34	190	5.5
23 916	16 mm	25	36	195	6
23 917	17 mm	25	38	210	6
23 918	18 mm	28	38	216	6.5
23 919	19 mm	28	42	230	6.5
23 920	20 mm	30	46	250	7.5
23 921	21 mm	32	45	245	7.5
23 922	22 mm	33	46	270	7.5
23 924	24 mm	36	49	280	8.5
23 927	27 mm	39	55	310	8.5
23 930	30 mm	44	59	340	9.5
23 932	32 mm	46	64	360	9.5
23 933	34 mm	50	70	380	15
23 935	36 mm	54	74	410	18
23 937	41 mm	61	84	460	21

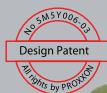

SlimLine-double ring and SlimLine combination spanner sets in canvas roll bag (for metric and imperial screw sizes) are featured on pages 30/31.



SlimLine spanners. Forged from CrV steel, carefully hardened and plated.

With clearly readable sizes.



10 year guarantee
For full professional use!



**DIN
ISO**

Each spanner has a clearly marked place for storage. The plastic holder also offers holes to allow for fixing it to a wall.

8-piece SlimLine double ring spanner set. Including holder. To DIN 838 and ISO 3318.

Sizes 6 x 7, 8 x 9, 10 x 11, 12 x 13, 14 x 15, 16 x 17, 18 x 19 and 20 x 22mm.

Each spanner has a clearly marked place for storage. The plastic holder also offers holes to allow for fixing it to a wall.

NO 23 810 set

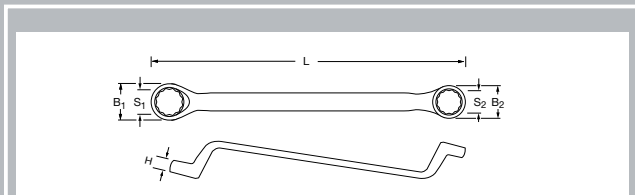

	S₁ x S₂	B₁	B₂	L	H
23 868	5 x 5,5 mm	9	10	162	5
23 870	6 x 7 mm	10	12	173	5,6
23 872	8 x 9 mm	13	14	182	6,1
23 874	10 x 11 mm	16	17	200	7,9
23 876	12 x 13 mm	18	19	212	8,5
23 878	10 x 13 mm	16	19	212	8,5
23 880	14 x 15 mm	21	23	225	9,8
23 882	16 x 17 mm	24	25	245	10,4
23 886	18 x 19 mm	27	28	260	11,3
23 888	17 x 19 mm	25	28	216	11,3
23 890	20 x 22 mm	30	32	285	12,8
23 892	21 x 23 mm	31	33	310	12,9
23 896	24 x 27 mm	34	38	335	13,9
23 900	30 x 32 mm	42	45	375	15,3



SlimLine spanners, packed in cardboard box.

Complete sets for sizes from 6 to 32mm. Hands-on tools.

21-piece SlimLine combination spanner set. From 6 to 32mm. To DIN 3113 and ISO 3318 (15° offset ring head).

10 year guarantee

For full professional use!



Sizes 6 – 7 – 8 – 9 – 10 – 11 – 12 – 13 – 14 – 15 – 16 – 17 – 18 – 19 – 20 – 21 – 22 – 24 – 27 – 30 and 32mm. Clearly arranged in a sturdy cardboard box.

NO 23 822 set

11-piece SlimLine open-end spanner set. From 6 to 32mm. To DIN 3110 and ISO 3318.

11-piece SlimLine double ring spanner set. From 6 to 32mm. To DIN 838 and ISO 3318.



Sizes 6 x 7, 8 x 9, 10 x 11, 12 x 13, 14 x 15, 16 x 17, 18 x 19, 20 x 22, 21 x 23, 24 x 27 and 30 x 32mm. Clearly arranged in a sturdy cardboard box.

Sizes 6 x 7, 8 x 9, 10 x 11, 12 x 13, 14 x 15, 16 x 17, 18 x 19, 20 x 22, 21 x 23, 24 x 27 and 30 x 32mm. Clearly arranged in a sturdy cardboard box.

NO 23 802 set

NO 23 812 set

SlimLine combination spanner sets for metric and imperial screw sizes. With 15° offset ring head. In practical canvas roll bag with holes for hanging up.

12-piece SlimLine combination spanner set for metric screw sizes.

12-piece SlimLine combination spanner set for imperial screw sizes.



Spanner sizes: 6 – 7 – 8 – 9 – 10 – 11 – 12 – 13 – 14 – 15 – 17 and 19mm.

NO 23 825

Spanner sizes: 1/4" – 9/32" – 5/16" – 11/32" – 3/8" – 7/16" – 1/2" – 9/16" – 5/8" – 11/16" – 3/4" and 13/16".

NO 23 816



Note:

Practical bag for hanging up in the workshop or to roll up for on the way.



Super safety and speciality bit set.

Nothing is impossible to unscrew!

■ Deep hole bits (80mm)

■ Regular bits (25mm)

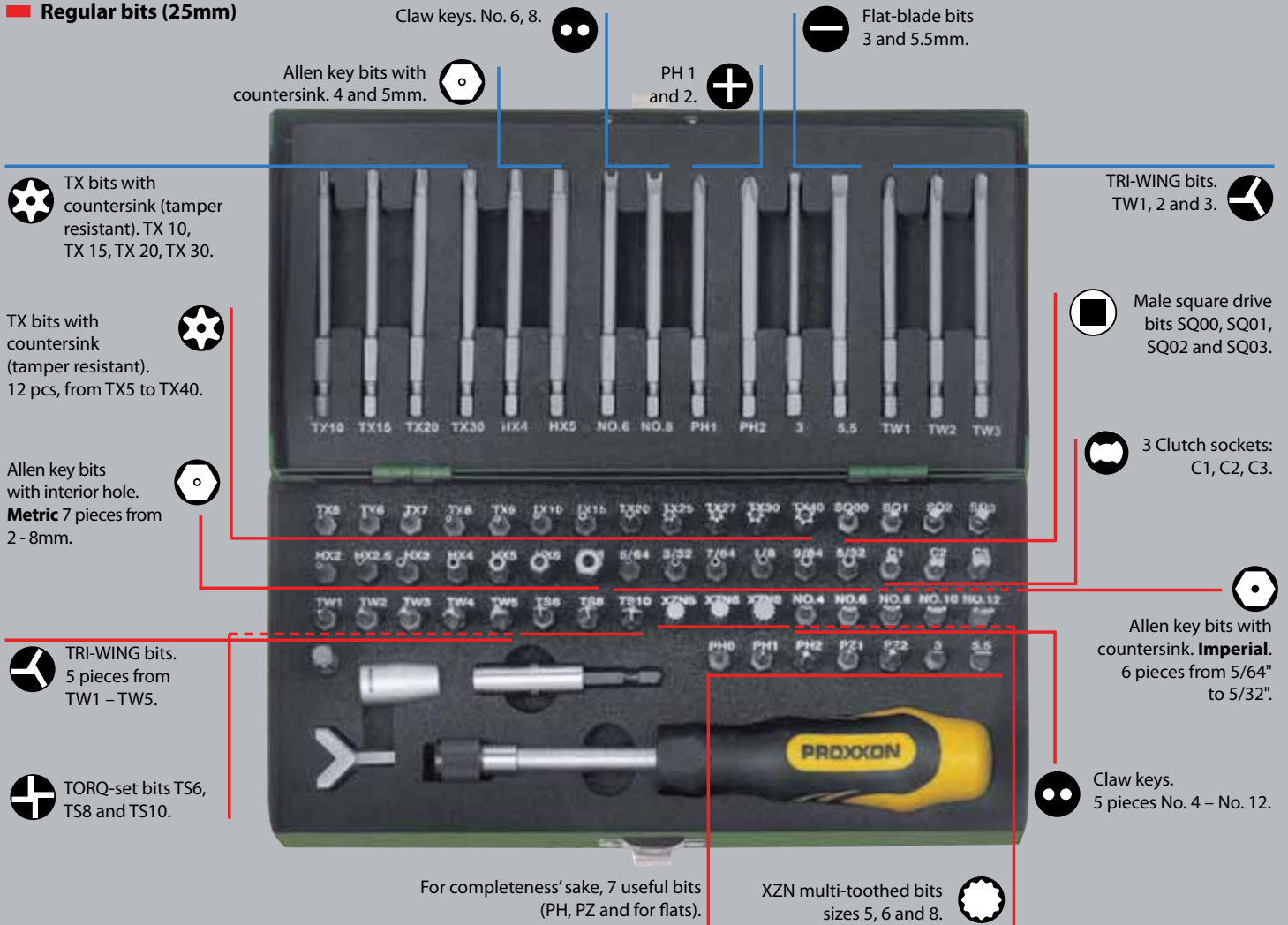

75-piece super safety and specialty bit set

With 1/4" special bits (6.3mm) in standard length (25mm) and extra long for tapped blind holes (80mm). Including screwdriver with positive spring-sleeve holder for bits. Magnetic holder for work with electric screwdriver or drill. Adapter with male square and male hex drive and matching attachment with female square and female hex drive.

Special attachment for centrally clamping screw hooks and similar parts. All in sturdy steel box with powder coated finish. All parts are clearly marked.

NO 23 107



9-piece Allen key set

With spherical finish on the long end (short end chamfered). One each 1.5 - 2 - 2.5 - 3 - 4 - 5 - 6 - 8 and 10mm. Chrome-vanadium steel. In foldable plastic holder.

NO 23 946

9-piece TX set

One each TX 8 - 10 - 15 - 20 - 25 - 27 - 30 - 40 and 50. Made from Nickel-Chrome-Molybdenum special steel. In foldable plastic holder.

NO 23 944



Screwdriver set with foldable ratchet-screwdriver and magnetic holder for working with electric screwdrivers.

DIN
ISO

2 year
guarantee

For full professional use!

Foldable screwdriver with ratchet mechanism:
To reach higher torque, simply bend the screwdriver handle. No need to swap over. For 1/4" standard bits.



Locking of the handle in normal and angled position at the push of a button. Reverse lever for clockwise and anticlockwise rotation by turning the shift ring. In centre position the ratchet function is eliminated. Autolock system: Bits are form-locked automatically when inserted by means of a spring and a magnet. To release, slide ejector backwards.
NO 22 288

Screwdriver set with foldable ratchet-screwdriver and magnetic holder, 54-piece.

With 35 bits 1/4" (6.3mm) in standard length (25mm) and 16 bits extra long (80mm) for tapped blind holes. Including adapter with male square and male hex drive as well as matching attachment with female square and female hex drive. Special attachment for centrally clamping screw hooks and similar parts. 10 sockets 1/4" from 5.5 – 13mm. In addition, magnetic holder for work with electric screwdriver or drill. In sturdy steel box (powder-coated).

NO 23 104

Bits in industrial quality, accurate and wear resistant.



Made of special chrome-molybdenum-silicon-manganese-vanadium steel alloy. Hardened according to latest production standards.

- ⊖ For slotted screws 3 – 5.5 and 10mm. Also in long version.
- ⊕ For PHILLIPS screws (PH) in sizes 1 – 2 and 3. Long version for sizes 1 and 2.
- ✱ For Pozidrive (PZ) screws in sizes 1 – 2 and 3.
- ⊗ For TX screws (with frontal hole) in sizes 8 – 9 – 10 – 15 – 20 – 25 – 27 – 30 and 40.
- ⊗ Long version for TX 10 – 15 – 20 – 25 – 30 and 40.
- ⊙ For Allen (HX) screws 2.5 – 3 – 4 – 5 and 6mm. Long version for HX 3 – 4 – 5 and 6mm.

8-piece pocket Allen key set

One each 1.5 – 2 – 2.5 – 3 – 4 – 5 – 6 and 8mm. Made from Chrome-Molybdenum special steel, galvanically plated. In pocket knife type plastic holder which also serves as a handle.
NO 23 956

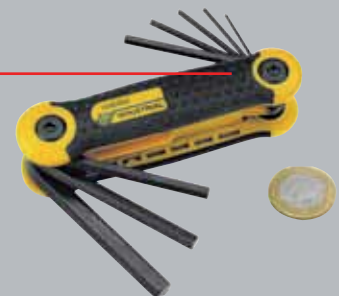

8-piece pocket TX key set

One each TX 9 – 10 – 15 – 20 – 25 – 27 – 30 and 40. Made from Nickel-Chrome-Molybdenum special steel. In pocket knife type plastic holder which also serves as a handle.
NO 23 954

FLEX-DOT screwdrivers. The allrounders for workshop and assembly.

PROXXON

INDUSTRIAL

DIN
ISO

2 year
guarantee

For full professional use!

Ergonomic design for proper handling:

Rounded two-component handle with flexible "FLEX-DOT" nubs for fatigue-proof and comfortable continuous use. Excellent grip attitude also with quick regripping. Combines high torques and pressure forces with balanced design for horizontal and vertical approach.

With transverse hole for hanging up or applying a lever.

Oil- and acid resistant non-stick special rubber handle.

Easy-to-read sizes through laser marking process on matte-chrome plated shafts of chrome-silicon-manganese-molybdenum special alloy steel.

Processed black tip for greatest precision for accepting screws. Also prevents tool from slipping.

Blade symbol and size on end of grip.

Finger recesses for more grip during fast turning.

With hexagon flat for using an open-end spanner as lever (for sizes 8 and 10 on slotted and PH3 and PZ3 version).



Flat-blade screwdrivers



NO	mm	mm	mm	mm
22 010	3	0.5	100	75
22 012	4	0,8	100	75
22 014	5.5	1	125	100
22 016	6.5	1.2	150	110
22 018	8	1.2	175	122
22 020	10	1.6	200	122
22 026 Stubby	5.5	1	25	60

HX (ball head) screwdrivers

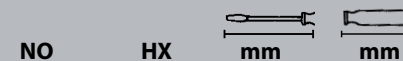

NO	HX	mm	mm
22 204	2	100	75
22 206	2.5	100	75
22 208	3	100	75
22 210	4	100	100
22 212	5	100	110
22 214	6	150	110
22 216	8	150	122



PHILLIPS screwdrivers

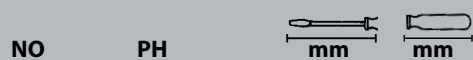

NO	PH	mm	mm
22 050	0	60	75
22 052	1	80	100
22 054	2	100	110
22 056	3	150	122
22 060 Stubby	2	25	60

POZIDRIV Phillips screwdrivers

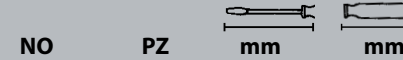

NO	PZ	mm	mm
22 070	0	60	75
22 072	1	80	100
22 074	2	100	110
22 076	3	150	122



TX Tamper screwdrivers (with frontal hole)

NO	TTX	mm	mm
22 230	8	75	75
22 232	10	100	100
22 234	15	100	100
22 236	20	100	100
22 238	25	100	110
22 240	27	100	110
22 242	30	100	110
22 244	40	100	110



HX nut screwdrivers

NO	HX	mm	mm
22 260	5.5	125	110
22 262	6	125	110
22 264	7	125	110
22 266	8	125	110
22 268	9	125	110
22 270	10	125	110
22 272	11	125	110
22 274	12	125	110
22 276	13	125	110

Screwdrivers with continuous hexagon blade and impact cap

For high stability during chiselling work and also offering a spanner flat for loosening tight screws. Separate impact cap form-locked to blade for vibration damping even when working with a steel hammer.



NO	mm	mm	mm	mm
22 104	6.5	1.2	150	110
22 108	8	1.2	200	120
22 134	PH 2		150	110

Screwdrivers for 1/4" standard bits and 1/4" sockets

For 1/4" hexagon standard bits (6.3mm). Steel screws stick to magnetised bit which facilitates positioning of the screws.

NO	mm	mm
22 281	100	110

For standard 1/4" hex bits (6.3mm). The auto-lock-system positively holds the bit. To release, push the sleeve backwards.

NO	mm	mm
22 282	110	110

For use with 1/4"-square sockets or 1/4"-hexagon standard bits (6.3mm). Choice between the two options simply by sliding the sleeve.

NO	mm	mm
22 283	110	110

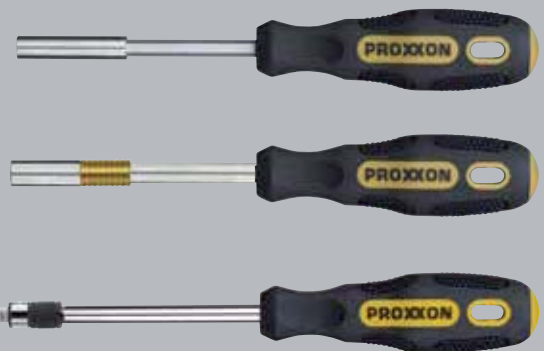

Popular screwdriver combinations for daily use.

FLEX-DOT 6-piece screwdriver sets

Combinations that are a must-have for every tool box. Complete initial equipment for mechanics and service technicians.

NO	Contents				
22 604	4 x Flat-blade:	3	4	5.5	6.5
	2 x Phillips:	PH 1	PH 2		
22 606	4 x Flat-blade:	3	4	5.5	6.5
	2 x Pozidriv:	PZ 1	PZ 2		
22 640	6 x Tamper-TX:	TTX 10	TTX 15	TTX 20	
		TTX 25	TTX 30	TTX 40	
22 642	6 x HX:	HX 2.5	HX 3	HX 4	HX 5
		HX 6	HX 8		
22 644	6 x HX: External	5.5	6	7	8
			10	13	



L-handle screwdrivers: Very robust with continuous blade.

PROXXON

INDUSTRIAL

If high torques are required for tightening or loosening screws, the L-handle screwdriver is the solution. The ergonomic and asymmetrical grip simplifies handling under continuous operation. Its two-component design with soft zones reduces pressure marks while at the same time allowing for optimum torque transfer. Easy-to-read sizes on shaft (laser marking) and handle.



L-handle HX screwdrivers
Short blade with sturdy standard HX, long blade with HX ball (ball head).

NO	HX	A mm	B mm	C mm
22 402	2	110	15	55
22 404	2.5	110	15	55
22 406	3	110	15	55
22 408	4	110	15	55
22 410	5	160	20	75
22 412	6	160	20	75
22 414	7	160	20	75
22 416	8	200	20	75
22 418	10	215	20	100

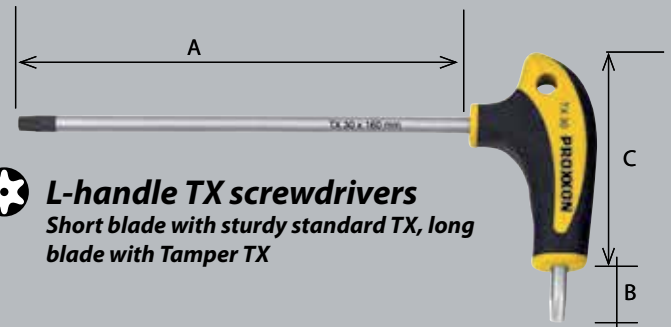

L-handle TX screwdrivers
Short blade with sturdy standard TX, long blade with Tamper TX

NO	TX	A mm	B mm	C mm
22 440	8	110	15	55
22 442	9	110	15	55
22 444	10	110	15	55
22 446	15	110	15	55
22 448	20	110	15	55
22 450	25	160	20	75
22 452	27	160	20	75
22 454	30	160	20	75
22 456	40	185	20	75
22 458	45	215	20	100
22 460	50	215	20	100

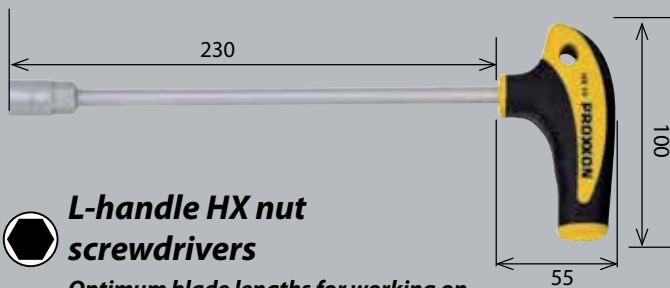

L-handle HX nut screwdrivers

Optimum blade lengths for working on motors and all kinds of machines. Flats on HX nut allow for use of an open-end spanner to effortlessly loosen tightly locked screws.

NO	HX mm
22 476	7
22 478	8
22 482	10
22 486	12
22 488	13



L-handle screwdriver sets

With versatile holder for the workshop. Clearly specified sizes on the holder for neat storage of L-handle screwdrivers.

NO	Contents
22 650	8-piece L-handle HX set with holder HX 2 – 2.5 – 3 – 4 – 5 – 6 – 8 – 10
22 652	10-piece L-handle TX set with holder TX 8 – 10 – 15 – 20 – 25 – 27 – 30 – 40 – 45 – 50

Insulated FLEX-DOT screwdrivers to VDE-Standard

Insulated VDE screwdrivers for work on or around live components up to 1,000V AC. Injection of the protective insulation onto the screwdriver blade and piece by piece inspection offer maximum safety.

PROXXON

INDUSTRIAL

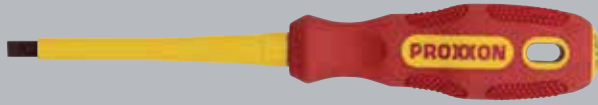

Insulated flat-blade screwdrivers

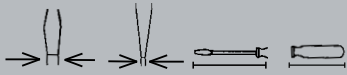

NO	mm	mm	mm	mm
22 300	2.5	0.4	75	75
22 304	4	0.8	100	100
22 306	5.5	1	125	100
22 308	6.5	1.2	150	110

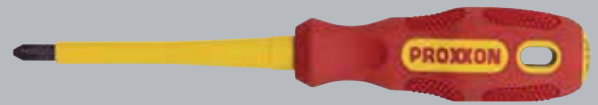

Insulated PHILLIPS screwdrivers



NO	PH	mm	mm
22 330	0	60	75
22 332	1	80	100
22 334	2	100	110

6-piece insulated VDE screwdriver set

NO	Contents
22 630	4x Flat-blade 2.5 4 5.5 6.5 2 x PH PH 1 PH 2



Voltage tester as per VDE 0680

Indication of voltage between phases 220 to 250V, 50/60Hz (up to 500Hz). Of high-strength ABS, with roughened, non-slip surface. Tested piece by piece at 2,000V. Blade length 60mm. Total length 140mm.

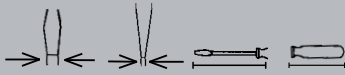

NO	mm	mm	mm	mm
22 390	3	0.5	60	75



2 year guarantee

For full professional use!

Precision screwdrivers for electronic engineers, camera builders, watchmakers, jewellers, precision engineers and model makers.

15-piece MICRO-Driver set







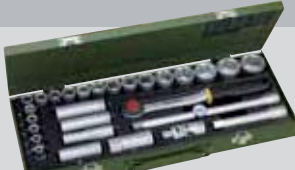

Blades of high alloy nickel-chrome-molybdenum steel (SAE 8660) for maximum hardness and toughness. Chrome-plated with brinelled tip. With ergonomically formed two-component handle of high-quality plastic (impact as well as oil and acid resistant) with soft component in the finger grip area. The revolving top and finger mould improve easy of use.

Flat-blade:	1 x 50 – 2 x 50 – 3 x 50
Phillips:	PH 000 x 50 – PH 0 x 50 – PH 1 x 50
TX:	T 5 x 50 – T 6 x 50 – T 8 x 50 – T 10 x 50 – T 15 x 50
HX:	1.5 x 50 – 2 x 50 – 2.5 x 50 – 3 x 50

NO 28 148

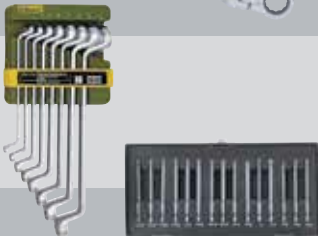

Contents

		Page/Pages
	Socket sets and tool sets 14-piece 3/4" socket set	3 – 10 18
	Universal and oil suction pump AP 12	9
	Ratchets, socket sets and drive elements	11 – 18
	Special workshop sets, adjustable wrenches IMPACT sockets for wheel nuts	19
	MicroClick torque screwdrivers and MicroClick torque wrenches	20 – 23
	MicroSpeeder and speeder ratchet spanners	24 – 27
	SlimLine spanners	28 – 31
	Specialty bit sets and key and pocket key sets	32 – 33
	FLEX-DOT screwdrivers MICRO-Driver	34 – 37 37

For the PROXXON MICROMOT-system there is a separate 70-page catalogue, which is available free of charge. Please send your request to the below mentioned address.



We reserve the right for technical modifications as a result of improvements.
Errors and omissions excepted.

PROXXON GmbH

Industriepark Region Trier • Dieselstraße 3 - 7 • DE-54343 Föhren
Phone: + 49 (0) 65 02 – 93 17 – 0 • Fax: + 49 (0) 65 02 – 93 17 – 200
e-mail export@proxxon.com • www.proxxon.com