



JONNESWAY®

PROFESSIONAL TOOL RANGE

8th Edition



Featuring PROUDLY ASSOCIATED BRANDS



VICES,
G-CLAMPS
& ACCESSORIES



MIG WELDING • PLASMA CUTTING • SPOT WELDING



JONNESWAY®

PROFESSIONAL TOOL RANGE

Introduction

JONNESWAY has been a market leader in the professional tool industry for over 33 years with an established distributor base in over 100 countries worldwide.

JONNESWAY is the largest tool range under one brand in South Africa. This extensive range caters for the aviation, industrial, automotive and refinishing industries comprising of a complete automotive, hand and pneumatic range. Tools available in these ranges are:

- Professional Hand Tools
- Pneumatic Tools
- Body Tools
- Engine Service Tools
- General Tools
- Brake, Suspension and Under Car Tools
- Electronic Tools
- Spray Painting Equipment

JONNESWAY promises quality to satisfy professional market demands. The entire Jonnesway tool range meets strict international standards, many exceeding the requirements as set by DIN and ANSI.

Gondolier aims to continue its proven reliability, providing technical support and excellent after sales service.



Tel: +27 11 704 4444
info@gondolier.co.za

Find us on the web & social media:



www.jonnesway.co.za



www.gondolier.co.za



www.facebook.com/jonneswaysa



www.facebook.com/GondolierSA



[@JonneswaySA](https://twitter.com/JonneswaySA)



AUTOMOTIVE

Body Tools	14
Brake, Suspension & Undercar Tools	28
Electronic Tools	20
Engine Service Tools.....	22
Garage & Workshop Tools.....	19
General Tools.....	17
Hydraulic, Gear Puller & Undercar Service.....	12



PNEUMATIC RANGE

Pneumatic Power Tools	34
Pneumatic Power Tool Consumables.....	44



PROFESSIONAL HAND TOOLS

Bit Sets.....	61
Extension Bars & Accessories	65
General (Saws, Tapes, Knives Etc.).....	93
Hammers	90
Impact / Deep Impact Sockets	63
Keys	91
Locking Pliers.....	88
Pliers / Cutters / Clamps.....	84
Ratchets & Torque Wrenches.....	57
Riveters.....	94
Screwdrivers.....	74
Socket & Ratchet Sets	58
Sockets – Individually Available.....	67
Toolboxes / Drawers/ Trolleys	77
Vise Crimpers	94
Wrench Sets.....	48
Wrenches - Individually Available	51



AIR CONTROL UNITS..... 95



SPRAY PAINTING EQUIPMENT.....95



BLACK STEEL VICES..... 98



TEMPIR WELDING EQUIPMENT..... 102



OTHER

Tempir Welding Blankets.....	105
Tecna Spot Welding Equipment.....	106
Space Bay	107
Jonnesway & Black Steel Retail Stands.....	108
Conversion Tables	110
Shows & Events	111



PRODUCT CODE GUIDE

JOA001	Multi Dolly	14
JOA002	Double End Hand Dolly	14
JOA003	Curved Dolly	14
JOA004	Toe Dolly.....	14
JOA005	Auto Repair Tool Set 6 Pc.....	14
JOA006	Speed File	16
JOA006a	Speed File Blade 9TPI.....	16
JOA006b	Speed File Blade 12TPI	16
JOA007	5 Piece, 8" File Set.....	16
JOA100	25 Pc 4t Hydraulic Gear Puller	12
JOA102	4t Hydraulic Puller	12
JOA103	Gear Puller Set.....	12
JOA104	Outer Tie Rod Remover.....	12
JOA105	Pitman Arm Puller.....	12
JOA106	Ball Joint Puller.....	12
JOA107	Bearing Separator 50mm x 75mm.....	13
JOA108	Bearing Separator 75mm x 105mm	13
JOA109	Bearing Separator 105mm x 150mm.....	13
JOA1104 / 1106 / 1108	2 Jaw Gear Puller	13
JOA1114 / 1116 / 1118	3 Jaw Gear Puller	13
JOA113	Heavy Duty Coil Spring Compressor.....	22
JOA114	10 lbs 9 Pc Dent Puller Set	14
JOA200	4t Portable Power Kit.....	14
JOA202	McPherson Spring Damper Extractor.....	23
JOA203	Vice for Shock Absorbers	22
JOA204	Bearing Hole Puller Kit	13
JOA205	10t Portable Power Kit	16
JOA300	Windshield Moulding/Door Handle Clip Pliers.....	15
JOA301	10 in 1 Trim Tool.....	15
JOA304	Door Upholstery Remover "V"	15
JOA305	Trim Remover Set.....	16
JOA306	Trim Remover Tool.....	15
JOA307	Flexible Magnetic Pick-up tool 525mm	18
JOA308	Universal Radiator Pressure Tester Adaptor	23
JOA400	Hand Sander Wooden Handle.....	15
JOA401	Sanding Block.....	15
JOA402	Pick Hammer.....	15
JOA403	Straight Peen & Finishing Hammer	15
JOA404	Heavy Shrinking Hammer (Flat Face).....	15
JOA405	Long Internal Snap Ring Pliers	17
JOA406	Magnetic Pick-up Tool.....	18
JOA407	Telescoping Inspection Mirror 580mm.....	18
JOA408	150mm Spare Parts Magnetic Dish	20
JOA409	Professional 3 Function Tyre Gauge	19
JOA410	Digital Tyre Pressure Gauge	19
JOA411	7 Pc Screw Extractor and Nap Set	19
JOA413	4 Pc Stud Puller Wrench Set (Metric).....	18
JOA414	14" Push & Foldable Cross-Handle Socket Wrench	19
JOA415 - JOA416	Straight Nose, Internal Circlip Pliers	17
JOA417 - JOA418	Bent Nose, Internal Circlip Pliers.....	17
JOA419 - JOA420	Straight Nose, External Circlip Pliers	17
JOA421 - JOA422	Bent Nose, External Circlip Pliers.....	17
JOA423	Rectangular Magnetic Tray (240 x 140mm).....	20
JOA424	Fender Cover 1050 x 650mm.....	19
JOA425	½" Dr. Impact Driver	19
JOA426	Feeler Gauge 20 Blade (0.05-1mm)	19
JOA427	Stainless Steel Ruler (300mm / 12").....	19
JOA428	6 Pc Pick and Hook Set.....	18
JOA430	2Pc "O" Ring and Hook scribe set	18
JOA431	Telescoping Inspection Mirror 50 x 92mm	18
JOA432	7Pc Stud Puller Wrench Set	18
JOA450	Hickory Handles	15
JOA500	Waste Oil Storage.....	20
JOA501	Radiator Pressure Tester	23



JOA502	Door Opening Holder Set	15
JOA600	Timing Light with Tach/Dwell/Volt Tester	21
JOA601	Digital Advance Timing Light with Tach/Dwell/Volt Tester.....	21
JOA602	Digital Automotive Analyser & Multi Meter	20
JOA603	Heavy Duty Circuit Tester	21
JOA604	Car Battery & Alternator Checker	20
JOA605	Battery Hydrometer	21
JOA606	Metal Case Battery Brush (Nickel Plated)	21
JOA607	Swivel Jaw Hose Clamp Pliers.....	17
JOA608	CV Joint Boot Clamp Pliers	31
JOA610	7 Pc Disconnect Set.....	22
JOA611	Rubber Spark Plug Remover and Installer	30
JOA612	6" Electronic Vernier Caliper (150mm).....	21
JOA616	Heavy Duty Circuit Tester	21
JOA617	Vernier Caliper Stainless Steel	21
JOA700	Tail Pipe Reshaper.....	16
JOA701	Fan Belt Tightener.....	22
JOA702 - JOA705	Piston Ring Compressors	27
JOA706	Petrol Engine Compression Tester Kit.....	27
JOA707	Universal Overhead Cam Valve Spring Compressor	23
JOA708	Lock Ring Pliers (Straight tip).....	17
JOA709	Vacuum Testing/Brake Bleeding Kit	26
JOA710	Oil Filter Wrench 3 Leg, 2 Way	24
JOA711	Oil Filter Wrench (Strap).....	24
JOA712	4 Pc Pry Bar Set.....	20
JOA713	Spark Plug Boot Pliers	31
JOA716	Stud Oil Filter Wrench 30 Pc.....	25
JOA717	Oil Pressure Tester Set	27
JOA718	Benz Crankshaft Pulley Holder	29
JOA719	BMW Camshaft Alignment Tool Kit	29
JOA720	Lock Ring Pliers (Angle Tip)	17
JOA721	Exhaust Spring Clamp Remover / Installer	24
JOA722	Internal Lock Ring Pliers	31
JOA723	Universal Twin/4 Cam Lock (Gas & Diesel Engines)	29
JOA724	Petrol Engine Twin Cam Locking/Setting Tool & Flywheel Holding Tool Kit	29
JOA725	Fuel Injection Test Kit.....	26
JOA726	2 Way Viscous Fan Spanner 32mm & 36mm	22
JOA727	Piston Ring Compressor Kit.....	28
JOA728	Piston Ring Groove Kit	28
JOA729	Valve Stem Seal Pliers (long).....	31
JOA800	Disc Brake Piston "Cube"	26
JOA801	Brake Spring Compressor	26
JOA802	Professional Seal Puller	22
JOA803	External & Internal Restorer Files.....	28
JOA804	Overhead Valve Spring Compressor	23
JOA805	External Thread Restoring Files.....	29
JOA806	External Thread Restoring Files.....	29
JOA807	External Thread Restoring Files.....	29
JOA808	Deluxe Brake Cylinder Hone	28
JOA80801	Replacement Stones - JOA808	28
JOA80901	Replacement Stones - JOA809	28
JOA809	Brake Cylinder Hone	28
JOA811	VW T4 Front Axle Upper Ball Joint Installer/Remover.....	24
JOA812	Benz (W140) Lower Control Arm Bush Remover/Installer	30
JOA814	BMW Bush Extractor/Installer.....	30
JOA815	BMW Hub Remover/Installer	24
JOA816	BMW Transmission Extractor/Installer.....	30
JOA817	MAN, BENZ Truck Diesel Injection Valve Socket	22
JOA818	Tubing Cutter and Double Flaring Tool Kit	20
JOA820a - JOA820b	Plug Key (metric) & Sump Plug Key (Imperial)	24
JOA821	Telescopic Tubing Cutter.....	20
JOA822	Dust Shield Installer	30
JOA823	Dust Shield Kit.....	30
JOA824	13 Pc Caliper Wind Back Tool	26
JOA825	FWD Front Wheel Bearing Adapter Set.....	13
JOA826	Bearing Race & Seal Driver.....	30
JOA827	87Pc Threaded Coil-Insert Repair Kit.....	22



JOA850	Diesel Engine Compression Tester Set (Cars) mm.....	27
JOP002	¾" Super Duty Impact Wrench 2" Anvil.....	34
JOP005	Composite Air Impact Wrench 1/2".....	34
JOP006	3/8" Dr. Pneumatic Heavy Duty Impact Wrench.....	36
JOP008	1" Square Dr. Super Duty Air Impact Wrench W/6" Extended Anvil.....	35
JOP100	½" Dr. Heavy Duty Air Ratchet Wrench.....	36
JOP1000 - JOP1001	¼" & ½" FRL Combination Unit.....	95
JOP102	3/8" Dr. Stubby Air Ratchet Wrench.....	36
JOP1200	Air Punch / Flange Tool.....	42
JOP200	3/8" Dr. Air Drill.....	39
JOP2000	¼" Universal Swivel Air Inlet Joint.....	44
JOP2001	3/8" Universal Swivel Air Inlet Joint.....	44
JOP2002	½" Universal Swivel Air Inlet Joint.....	44
JOP201	3/8" Dr. Air Reversible Drill.....	39
JOP202	½" Dr. Air Drill.....	39
JOP203	½" Dr. Air Reversible Drill.....	39
JOP204	Air Spot Weld Drill with Hook.....	40
JOP205	3/8" Air Angle Reversible Drill.....	40
JOP206	3/8" Composite Heavy Duty Air Reversible Drill.....	39
JOP207	1/2" Composite Heavy Duty Air Reversible Drill.....	39
JOP2100	In Line Regulator.....	44
JOP250	5 Pc 8.0mm diam. Spot Drill Bit Set HSS.....	44
JOP252	5 Pc 8.0mm diam. Spot Drill Bit Set Titanium HSS.....	44
JOP301	Air Impact Screwdriver (Twin Hammer).....	38
JOP302	Air Impact Screwdriver (Twin Hammer).....	38
JOP400	6mm Heavy Duty Mini Air Die Grinder.....	37
JOP401	6mm Heavy Duty Mini Angle Air Die Grinder.....	37
JOP402	7" Professional Angle Grinder (Lever Throttle).....	37
JOP403	5" Professional Air Angle Grinder (Lever Throttle).....	37
JOP405	¼" Heavy Duty Air Die Grinder.....	37
JOP405K	Laser Weld Cutter.....	40
JOP406	7" Extension 6mm Air Die Grinder.....	37
JOP452	PU Velcro Sanding Pads Hard Surface.....	44
JOP453	PU Velcro Sanding Pads Soft Surface.....	44
JOP454	Interface Pads.....	44
JOP501	Shock Reduction Air Hammer Kit (Hex).....	43
JOP502	Air Needle Scaler.....	36
JOP502ap	Chisel for Air Needle Scaler JOP502.....	44
JOP502aq	12 Pc Needle Set for Air Needle Scaler JOP502.....	44
JOP503	Air Stripping Tool (Label and Sticker Remover).....	38
JOP50349	Eraser Pad.....	45
JOP550	5 Pc Long Chisel (Hex) Shank 0.39", l 125mm.....	44
JOP551	Tapered Punch for Air Hammer, l 170mm (A).....	44
JOP552	Flat Chisel for Air Hammer, l 170mm (B).....	44
JOP553	Spot Weld cutter for Air Hammer, l 170mm (C).....	44
JOP554	Single End Cutter for Air Hammer, l 170mm (D).....	44
JOP555	Panel Cutter for Air Hammer, l 170mm (E).....	44
JOP600	Low Vibration Mechanism Air Saw Kit.....	43
JOP601	Finishing Air File.....	36
JOP603	Air Hydraulic Riveter 3/16" (4.8mm).....	42
JOP604	¼" (6.4mm) Heavy Duty Air Hydraulic Riveter.....	42
JOP606	3" Cut Off Tool.....	38
JOP650	5 Pc Saw Blade 18 Teeth for Air Saw, l 75mm.....	45
JOP651	5 Pc Saw Blade 24 Teeth for Air Saw, l 75mm.....	45
JOP652	5 Pc Saw Blade 32 Teeth for Air Saw, l 75mm.....	45
JOP653	115mm Blades for Air Windshield Knife.....	44
JOP654	153mm Blades for Air Windshield Knife.....	44
JOP655	203mm Blades for Air Windshield Knife.....	44
JOP656	Triangular File for Finishing Air File. Shank 5mm.....	45
JOP657	Half Round File for Finishing Air File. Shank 5mm.....	45
JOP658	Round File for Finishing Air File. Shank 5mm.....	45
JOP659	Rectangular File for Finishing Air File. Shank 5mm.....	45
JOP705	7" Air Sander.....	41
JOP706	7" Air Vertical Sander.....	41
JOP709 - JOP711	Composite Random Orbital Sander, Central Vacuum.....	41
JOP710 - JOP712	Composite Random Orbital Sander, Self-Generated Vacuum.....	41
JOP800	7" Air Polisher.....	41



JOP801	3" Composite Heavy Duty Air Polisher	41
JOP801BE	3" Velcro Pad for JOP801	44
JOP900	Air Grease Gun (400CC)	38
JOP901	Heavy Duty Manual Operated Grease Gun	38
JOP801BE	3" Velcro Pad for JOP801	44
JOP901	Heavy Duty Manual Operated Grease Gun	38
JOT010	Torque Screw Driver	75
JOT014 - JOT020	Micrometer Torque Wrenches, 48 Teeth	57
JOT10003 - JOT10008	Measuring Tapes	93
JOT200 - JOT212	Quick Release Anti Slip Grip Reversible Ratchet Handle – 36 Teeth	57
JOT202 - JOT204	Anti Slip Grip Ratchet Handle, 72 Teeth	57
JOT205 - JOT206	Quick Release Anti Slip Grip Stubby Ratchet Handle, 48 Teeth	57
JOT207	8 Pc 72 Teeth Ratcheting Combination Wrench Set (SAE)	50
JOT20810	10 Pc 72 Teeth Stubby Type Ratcheting Combination Wrench Set (mm)	49
JOT2081116 - JOT208916	72 Teeth Stubby Type Ratcheting Combination Wrench (mm)	53
JOT209	7 Pc Flexible Ratchet Wrench Set (SAE)	49
JOT213 - JOT216	Quick Release Anti-Slip Grip Reversible Ratchet Handle - 48 Teeth	57
JOT2151719 - JOT2153032	Double Socket Ratchet Wrench (Construction Wrench)	55
JOT217	Ratchet Handle – 48 Teeth	57
JOT218	Ratchet Handle – 36 Teeth	57
JOT301	8 Pc 72 Teeth Ratcheting Combination Wrench Set (mm)	49
JOT30106	6 Pc 72 Teeth Ratcheting Combination Wrench Set (mm)	49
JOT302	7 Pc 72 Teeth Reversible Ratcheting Combi Wrench (mm)	49
JOT30210 - JOT30219	72 Teeth Reversible Ratcheting Combi Wrench (mm)	52
JOT30310 - JOT30319	Combination Wrench Long Pattern Type (mm)	51
JOT304 - JOT307	Double Ended Ring Spanner (mm)	54
JOT308 - JOT313	Flare Nut Wrench (mm)	55
JOT314	6 Pc Flare Nut Wrench Set (mm)	48
JOT31406 - JOT31450	Combination Wrench (mm)	51
JOT315	26 Pc Combination Wrench Set (mm)	48
JOT316	8 Pc Midget Combination Wrench Set (SAE)	48
JOT316516 - JOT31634	Midget Spanner (SAE)	53
JOT317	8 Pc 3/8" Dr. Crowfoot Wrench Set (SAE)	56
JOT318	10 Pc 3/8" Dr. Crowfoot Wrench Set (mm)	56
JOT31906 - JOT31963	Combination Wrench (SAE)	54
JOT320	12 Pc 75 Degree Offset Combination Wrench Set (mm)	48
JOT32006 - JOT32024	75° Combination Wrench (mm)	51
JOT340	14 Pc Combination Wrench Set (mm)	48
JOT341	8 Pc Midget Combination Wrench Set (mm)	48
JOT34108 - JOT34119	Midget Spanner (mm)	53
JOT342	8 Pc 75° Offset Ring Wrench Set (mm)	48
JOT343 - JOT348	E-Torx Wrench	55
JOT349	14 Pc Combination Wrench Set (SAE)	48
JOT3508 - JOT3515	Tiger's Paw Adjustable Wrench	56
JOT35110	10" Adjustable Angle Wrench	56
JOT35210 - JOT35218	Pipe Wrench	56
JOT400	1/4" Dr. Socket Set 18 Pc	58
JOT400S22H130	Flexible Handles	66
JOT400S22H150	Flexible Handles	66
JOT401S10PH1 - PH3	1/4" Dr. Phillips Bit Sockets	74
JOT401S16H1234 - H3410	Adapters	66
JOT401S1004 - 401S1055	1/4" Dr. Slotted Bit Sockets	74
JOT404	77 Pc 1/2" & 1/4" Dr. Tool Kit	83
JOT4042810	Water Pump Pliers 10"	88
JOT404S26H2	1/4" Dr. Spinner Handle	56
JOT405	15 Pc 3/4" Dr. 6Pt Flank Socket Set	58
JOT405ac - JOT405ad	3/4" DR. Extension Bar	66
JOT405ad	3/4" Dr. Reversible Ratchet Handle, 24 Teeth	57
JOT405ae - JOT405an	3/4" Dr. 6Pt Flank Sockets	69
JOT406	11 Pc 1/2" Dr. 6Pt Flank Impact Socket Set (mm)	63
JOT408	1/2" & 3/8" Dr. Power Bit Set 40 Pc	61
JOT40838 - JOT469	Bit Holders	61
JOT4094 - JOT40913	1/4" Dr. 6Pt Flank Sockets	68
JOT4104 - JOT41013	1/4" Dr. 6Pt Flank Deep Sockets	69
JOT4116 - JOT41124	3/8" Dr. 6Pt Flank Sockets	68
JOT4126 - JOT41224	3/8" Dr. 6Pt Flank Deep Sockets	70
JOT4138 - JOT41332	1/2" Dr. 6Pt Flank Sockets	69



JOT4148 - JOT41432	½" Dr. 6Pt Flank Deep Sockets.....	69
JOT4156 - 41530	¼" Dr. Torx Bit Sockets.....	72
JOT41610 - JOT41650	3/8" Dr. Torx Bit Sockets.....	72
JOT41712 - JOT41796	3/8" Dr. 12Pt Deep Sockets.....	68
JOT41716	Speed Brace.....	65
JOT41720 - JOT41770	½" Dr. Torx Bit Sockets.....	72
JOT4181132 - JOT418932	1/4" Dr. 12Pt Deep Sockets (SAE).....	68
JOT41816	Speed Brace.....	65
JOT41820 - JOT41870	½" Dr. Torx Bit Sockets.....	72
JOT4196 - JOT4199	¼" Dr. Torx Bit Sockets (Tamperproof).....	71
JOT42010 - JOT42050	3/8" Dr. Torx Bit Sockets (Tamperproof).....	71
JOT42155 - JOT42170	½" Dr. Torx Bit Sockets (Tamperproof).....	71
JOT4223 - JOT4227	¼" Dr. Hex bit Sockets.....	73
JOT4234 - JOT4239	3/8" Dr. Hex Bit Sockets.....	73
JOT4244 - JOT42416	1/4" Dr. Slotted Bit Sockets.....	74
JOT4254 - JOT42519	1/2" Dr. Hex Bit Sockets.....	73
JOT42614 - JOT42621	3/8" Dr. Spark Plug Sockets.....	70
JOT42716 & JOT42721	½" Dr. Spark Plug Sockets.....	70
JOT428	Flexible Handle 450 mm.....	66
JOT429	Flexible Handle p600 mm.....	66
JOT4308 - JOT43017	Sliding T-Handle Sockets.....	65
JOT431	14 Pc ¼" & 3/8" & ½" Dr. E Torx Socket Set.....	60
JOT431204 - JOT431208	1/4" Dr. 6Pt Star Socket.....	71
JOT431416 - JOT431424	½" Dr. Female Star Sockets.....	71
JOT432	½" Dr. Universal Joint.....	63
JOT43710 - JOT43732	½" Dr. Impact Sockets.....	64
JOT43819 - JOT43850	¾" Dr. Impact Sockets.....	64
JOT43917 - JOT43922	½" Dr. Thin Wall Deep Impact Socket.....	62
JOT4401 - JOT4403	Universal Joints.....	65
JOT4418 - JOT44120	3/8" Dr. Female Star Sockets.....	71
JOT443	25 Pc ¼" Dr. Socket Set.....	58
JOT444	8 Pc Extension Bar Set.....	66
JOT445	6 Pc Wobble Extension Bar Set.....	66
JOT446	13 Pc ½" Dr. Socket Set (SAE).....	60
JOT44601 - JOT44613	1/2" Dr. 12Pt Sockets (SAE).....	67
JOT447	11Pc 3/8" Dr. 12Pt Socket Set (SAE).....	60
JOT44701 - JOT44711	3/8" Dr. 12Pt Sockets (SAE).....	67
JOT448	12 Pc 3/8" Dr. 6Pt Flank Impact Socket Set (mm).....	63
JOT449	9 Pc Two Way Star & Tamperproof Key Set.....	91
JOT451 - JOT451b	Adapter for T Handle65.....	66
JOT45203 - JOT45236	Extension Bars.....	66
JOT454145	Flexible Extension Bars.....	65
JOT45504 - JOT45508	½" Dr. Extension Bars - Impact.....	63
JOT45610 - JOT45632	½" Dr. 6Pt Flank Deep Impact Sockets.....	64
JOT45708 - JOT45716	3/4" DR. Extension Bar.....	66
JOT45722 - JOT45750	3/4" Dr. 12Pt Flank Sockets.....	68
JOT458	Torx Bit Socket Sets on Rail ¼", 3/8" ½" 16 Pc.....	60
JOT459	Torx Bit Socket Sets on Rail ¼", 3/8" ½" 16 Pc.....	60
JOT460	Double Flexible Socket Wrench Set 6 Pc (mm).....	56
JOT4600809 - JOT4601819	Double Flexible Socket Wrench (mm).....	56
JOT461 - JOT405aa	Sliding T-bar.....	67
JOT462	3/4" Dr. 12Pt Flank Socket Set (SAE) 15 Pc.....	58
JOT463	8 Pc Two Way Ball Point and Hex Key Set.....	91
JOT464	8 Pc Two Way Star and Tamperproof Key Set, SNCM+V, Mat Finish.....	92
JOT46512 - JOT46513	3 Way T-Handle Socke.....	65
JOT466	1/4" Dr. Universal Spinner Handle.....	65
JOT467	Speed Brace.....	65
JOT468	13 Pc 1/2" Dr. Alternator Insert Bit Socket Set.....	24
JOT47038	4 Pc 3/8" Dr. Lock Extension Bar Set.....	66
JOT47117 - JOT47121	½" Dr. Wheel Torque Sockets.....	65
JOT47208	Ribe Bit Socket.....	70
JOT476	15 Pc 10mm Hex Bit Set.....	62
JOT47810 - JOT47819	1/2" Dr. 12Pt Sockets (mm).....	67
JOT479	18 Pc 1/2" Dr. Hex Bit Socket Set.....	62
JOT480	25 Pc 3/8" Dr. Socket Set.....	58
JOT481	7 Pc 3/8" & ½" Dr. Ribe Bit Socket Set.....	61
JOT48106 - JOT48114	Ribe Bits Socket.....	70



JOT482	31 Pc Screwdriver Bit Set.....	61
JOT483	15 Pc 10mm Star Bit Set.....	62
JOT484	18 Pc 1/2" Dr. Star Bit Socket Set.....	62
JOT48506 - JOT48555	1/4" Dr. 12Pt Sockets (SAE).....	67
JOT486	8 Pc 1/2" Dr. Hex Bit Impact Socket Set.....	63
JOT486H5 - JOT486H19	1/2" Dr. Hex Bit Impact Socket.....	64
JOT487	8 Pc 1/2" Dr. Torx Bit Impact Socket Set.....	63
JOT487T30 - JOT487T80	1/2" Dr. Star Bit Impact Sockets.....	64
JOT488	11Pc 10mm Spline Bit Set.....	62
JOT489	33 Pc 1/4" Dr. Security Bit Set.....	61
JOT491 - JOT493	Flexible Shaft Nutdrivers.....	65
JOT500	8 Pc Non Slip Grip Screwdriver Set.....	74
JOT5001 - JOT50025	Full Star Screwdrivers.....	76
JOT501	10 Pc Mechanic Go Thru Impact Screwdriver Set.....	74
JOT5021 - JOT5024	Full Star Pozi Screwdrivers.....	76
JOT504175 - JOT50433125	Go-Thru Impact Screwdrivers.....	76
JOT504238 - JOT5046538	Stubby Screwdrivers.....	76
JOT505	8 Pc Precision Screwdriver set.....	74
JOT505P0 - JOT505S30	Precision Screwdrivers, Phillips & Slotted.....	75
JOT506	7 Pc VDE Insulated 1000 volts Screwdriver set.....	75
JOT506060 - JOT5066150	VDE Insulated 1000 volts Screwdriver.....	75
JOT507T5 - JOT507T20	Precision Torx Screwdrivers.....	75
JOT508	53 Pc Flexible Ratchet Screwdriver Bit Set.....	75
JOT508a	Magnetic Quick Release Bit Holder.....	61
JOT514	5 Pc Go Through Impact Screwdriver set.....	74
JOT515	9 Pc Anti-Slip Grip Torx Screwdriver Set.....	75
JOT601	7 Drawer Tool Trolley (Tools not included).....	84
JOT602	6 Drawer medium Tool Top Chest.....	84
JOT603	6 Drawer Large Tool Top Chest.....	84
JOT607	Tool Chest Set 62 Pc.....	77
JOT610	Tool Chest Set 92 Pc.....	82
JOT612	62 Pc Black Edition Tool Chest Set.....	80
JOT613	253 Pc Black Edition Tool Trolley.....	78
JOT614	196 Pc Black edition 6 Drawer tool top chest set.....	81
JOT615	7 Drawer Black Edition Tool Trolley, sold seperately.....	79
JOT641	40 Pc 3/8" and 1/2" Dr. Power Bit Set.....	62
JOT642	7 Pc 1/2" Dr. Impact Socket Accessory Set.....	63
JOT643	22 Pc 1/2" Dr. Impact Socket Set (mm).....	63
JOT650	5 Pc Hammer & Chisel Set.....	94
JOT650a - JOT650c	Cold Chisel.....	93
JOT651	4 Pc Internal & External Pliers Set.....	86
JOT652	8 Pc Non Slip Grip Screwdriver Set.....	74
JOT654	8 Pc Two Way Ball Point & Hex Key Set.....	92
JOT657	14 Pc Hacksaw, Chisel, Punch, Wrench Set.....	94
JOT658	3 Pc Professional Pliers Set.....	86
JOT659018	8" Combination Side Cutting Pliers.....	85
JOT659038	8" Diagonal Side Cutters.....	85
JOT660	3 Pc Pliers Set.....	86
JOT661	Pliers Set.....	86
JOT663	5 Pc Mechanic Tool Set.....	67
JOT664	56 Pc 1/4" & 3/8" Dr. Flank Socket Wrench Set.....	60
JOT666	5 Pc 1/2" Dr. 6Pt Flank Socket Wrench Set.....	60
JOT668	24 Pc 1/2" Dr. Socket Wrench Set.....	59
JOT668a	Flexible Handles.....	66
JOT669	26 Pc 1/2" Dr. Socket Wrench Set.....	59
JOT670	28 Pc 1/2" Dr. Socket Wrench Set.....	59
JOT671R2804	Ratchet Handle - 48 Teeth.....	57
JOT673	27 Pc 1/2" & 3/8" Dr. Socket Bit Set.....	62
JOT673M10110 - M855	1/2" Dr. Multi Spline Socket Bit.....	70
JOT674	12 Pc Non-slip Close End and Fast Operating Wrench Set.....	50
JOT67410 - JOT67422	Non-slip Close End and Fast Operating Wrench (mm).....	55
JOT677	8 Pc 75° Offset Ring Wrench Set.....	50
JOT679	10 Pc Wrench Set & Ratchet Handle.....	50
JOT681	16 Pc Combination Wrench Set.....	50
JOT682	8 Pc Mechanic Tools Set.....	50
JOT683	10 Pc Combination Wrench with Measuring Tape Set.....	50
JOT684	6 Pc 45° Offset Ring Wrench Set.....	50



JOT687	16 Pc 72 Teeth Ratchet Combination Spanner Set (mm).....	49
JOT68708 - JOT68719	72 Teeth Ratcheting Combination Wrench (mm).....	52
JOT689	7 Pc Flexible Ratcheting Combination Wrench Set 72 Teeth (mm).....	49
JOT68908 - JOT68919	72 Teeth Flexible Ratcheting Combination Wrench (mm)	52
JOT692	18 Pc 3/8" Dr. Socket Set (SAE).....	59
JOT693	20 Pc 3/8" Dr. Socket Set5859	60
JOT695 & JOT697	Long Nose Pliers.....	85
JOT700 & JOT404088	Combination Pliers8.....	5
JOT702	Curved Jaw Locking Pliers 10".....	89
JOT703	Straight Jaw Locking Pliers 10".....	89
JOT704	Long Nose Locking Pliers 9".....	89
JOT705	Welding Clamps 11".....	89
JOT706 & JOT70618	C-Clamp with Standard Tip	89
JOT708	8" Welding Pliers.....	85
JOT7088 - JOT70816	Tongue in Groove Water Pump Pliers.....	88
JOT709	Easy Shift Internal-External Snap Ring Pliers	86
JOT710	Miniature Needle Nose Pliers	87
JOT711	Miniature End Cutting Nippers.....	87
JOT712	Miniature Diagonal Pliers.....	87
JOT713	Miniature Lineman's Pliers.....	87
JOT714	Miniature Long Nose Pliers	87
JOT71508 - JOT71510	Sheet Metal Locking Pliers.....	89
JOT7161	Aviation Tin Snips - Left	87
JOT7162	Aviation Tin Snips - Straight	87
JOT7163	Aviation Tin Snips - Right	87
JOT71714 - JOT71730	Bolt and Cable Cutter.....	84
JOT718	Wire Twisting Pliers.....	88
JOT720	8" Wire Cutters.....	88
JOT721	8" End Cutters.....	88
JOT723	9" Multipurpose Side Cutting Pliers.....	85
JOT724	8" End Cutters.....	88
JOT72507 - JOT72510	Curved Jaw Locking Pliers with TPR Handle	89
JOT72610	Straight Jaw Locking Pliers with TPR Handle 10".....	89
JOT72709	Long Nose Locking Pliers with TPR Handle 9".....	89
JOT72808	8" Combination Pliers with TPR Handles	86
JOT72908	8" Long Nose Pliers with TPR Handles	86
JOT73008	8" Diagonal Cutting Pliers with TPR Handles	86
JOT73111	11" Long Pliers.....	88
JOT73207	7" Compound Action Diagonal Cutting Pliers.....	86
JOT733 & JOT734	Combination Pliers.....	85
JOT737	6" Diagonal Cutting Pliers	85
JOT740	Self Locking Multi-grip Pliers - Wide Flat Jaws	88
JOT741	Self Locking Multi-grip Pliers - Double Curved Jaws	88
JOT742	Self Locking Multi-grip Pliers - Wide Curved Jaws	88
JOT743	Self Locking Multi-grip Pliers - Angled Jaws	88
JOT744	Self Locking Multi-grip Pliers - Straight Jaws.....	88
JOT8008 - JOT80032	Ball Peen Hammer - Fiberglass Handle	90
JOT8018 - JOT80132	Ball Peen Hammer - Hickory Handle.....	90
JOT80216 - JOT80220	Claw Hammer Fibre glass Handle	90
JOT8037 - JOT80320	Claw Hammer Hickory Handle.....	90
JOT80516 - JOT80520	Solid Steel One Piece Claw Hammer.....	90
JOT80625 - JOT8064	Hammer With Shockwave TPR Grip.....	90
JOT807100 - JOT8071000	DIN Engineers Hammer	91
JOT80835 - JOT80865	Dead Blow Hammer.....	91
JOT809100 - JOT809800	Joiner's Hammer.....	91
JOT81020	Carpenter's Hammer.....	90
JOT81416	Soft Face hammer.....	90
JOT893	7 Pc Hex Key Set (Folding) mm	91
JOT894	9 Pc Extra Long Arm Hex Key Set	92
JOT895	10 Pc Extra Long Arm Star Key Set.....	92
JOT899	9 Pc Extra Long Arm Ball Point Hex Key Set (SAE).....	92
JOT900	Extra long Arm Ball Point Hex Key	92
JOT901	8 Pc Star Key Folding Set.....	91
JOT902	6 Pc Pin Punch Set.....	93
JOT903	Retractable Utility Knife with 2 Pc Blade	93
JOT904	Heavy Duty Hacksaw with 12" High Strength Steel Blade	93

JOT905	10 Pc Extra Long Arm Star Tamper Proof Key Set.....	92
JOT906	Free Suction Hand Riveter.....	94
JOT907	Smart Vise Crimper – Insulated Terminals.....	94
JOT908	Crimp Tool Smart Vise Crimper - Barrel Connectors.....	94
JOT910	Smart Vise Crimper - CATV Connectors.....	94
JOT911	Smart Vise Crimper - 6 Position Modular Plugs.....	94
JOT914	Heavy Duty Easy Stripper.....	93
JOT915	Scissor Action Industrial Riveter.....	94
JOT916	Professional Riveter Nut Tool Kit.....	95
JOT920 - JOT928	Centre Punch.....	93
JOT924	6 Pc Pin Punch Set.....	93
JOT925	22 Pc 1/4" Dr. Socket Set (Maxi Drive, Polish Finish) SAE.....	59
JOT927	24 Pc 3/8" Dr. Socket Set (SAE).....	59
JOT929	20 Pc 1/2" Dr. 1000V Insulated Socket Set.....	60
JOS001	Deluxe Professional Gravity Feed Spray Gun.....	95
JOS050	1.4mm Nozzle Set for JA-6111.....	95
JOS051	Gasket & Spring Set for JA-6111.....	95

BLACK STEEL VICES

BSV001 - BSV004	Professional Fixed Base Vice.....	98
BSV005 - BSV008	Professional Swivel Base Vice.....	98
BSV009	Woodworkers Vice 7".....	98
BSV012-BSV014	Aluminium Jaw Covers.....	99
BSV015-BSV017	Nylon (PVC) Jaw Covers.....	99
BSV018 - BSV021	Swivel Bases.....	99
BSV022-BSV028	G-Clamps SG Iron.....	99
BSV032 - BSV033	Drill Press Vice.....	99
BSV040 - BSV046	Jaws with fixing bolts.....	99
BSV047-BSV048	SG Iron Extra Strong Fixed Base Vice.....	98
BSV053-BSV054	Handles for workshop Vices.....	99

TEMPIR WELDING EQUIPMENT

TEM002	MIG 155 S/PH, 150A.....	102
TEM004	MIG 190 3/PH, 200A.....	102
TEM005	MIG 2612 S/PH, 250A.....	102
TEM006	MIG TRI 213 3/PH, 200A.....	102
TEM007	MIG 2932 3/PH, 290A.....	103
TEM009	PLASMA P40 3/PH, 40.....	106
TEM010	PLASMA P55 3/PH, 50A.....	103
TEM011	PLASMA P80 3/PH, 40.....	103
TEM012	Single SPOT Dent Puller 3888 S/PH, 3000A104.....	105
TEM013	MIG/MAG 4032C, 400A.....	103
TEM014	Digital Hybrid Plastic Welder S/PH, 230V104.....	105
TEM015	Cut 40 HF 220V Inverter Cutter.....	104
TEM017	MIG 190 EVO S/PH, 160A.....	102
TEM300	Tempir Welding Blanket.....	105

TECNA SPOT WELDING

TEC022 - TEC023	Portable 6KVA Watercooled Spot Welder.....	106
TEC337	Hand Held Double Sided Spot Welder.....	106

SPACE BAY

SPA001	2 Pillar Aluminium Bay.....	107
SPA002	4 Pillar Aluminium Bay.....	107
SPA010y/r - pSPA014y/r	Protective Sheets (only).....	107
SPA015y/r - pSPA016y/r	Complete Welding Screen.....	107

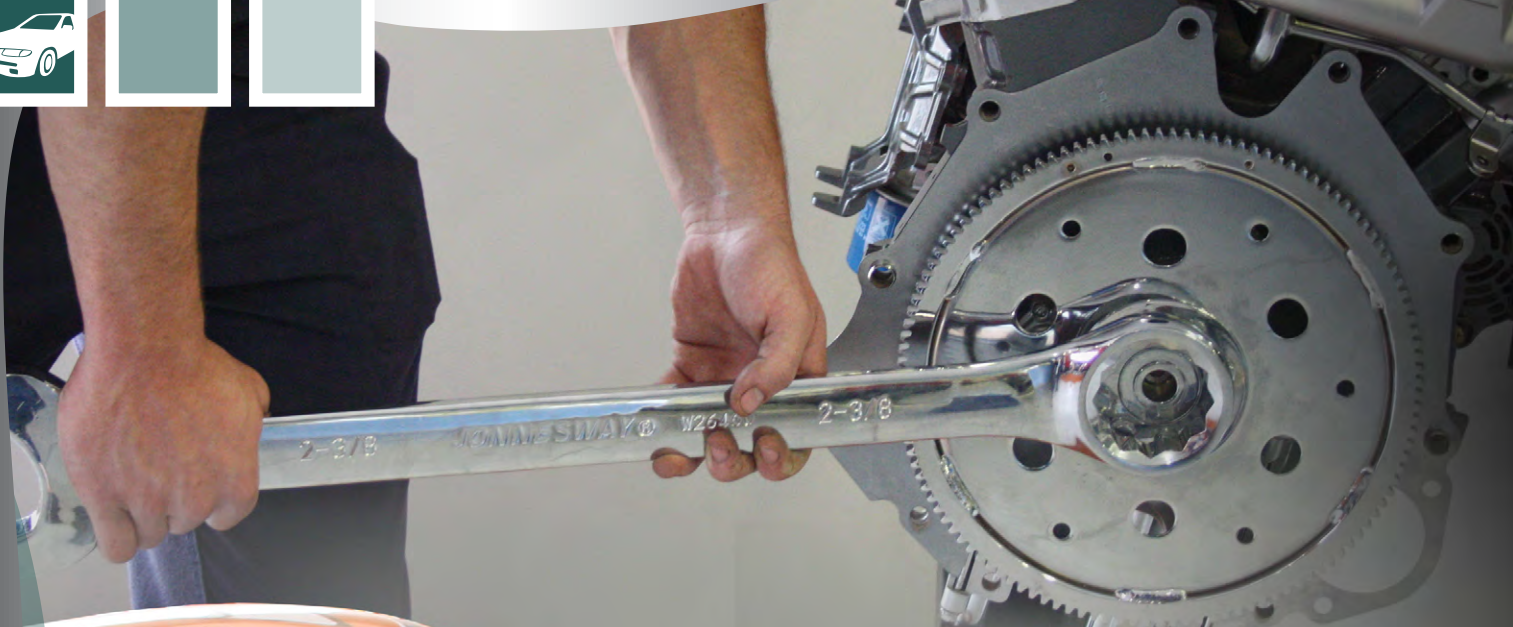



AUTOMOTIVE



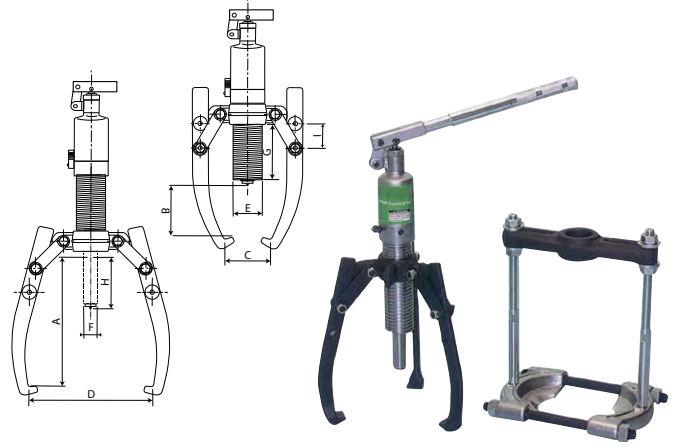

JOA100 AE310002	25 Pc 4t Hydraulic Gear Puller
1 Pc Hydraulic Ram (SCM415 Ø 37.7mm x l 160mm x 16t)	
3 Pc 4" Leg Hardened 42 -45 (SCM415)	
3 Pc 6" Leg Hardened 42 -45 (SCM415)	
3 Pc 8" Leg Hardened 42 -45 (SCM415)	
1 Pc Twin Head	
1 Pc Triple Head	
1 Pc Sent Pop (Carbon Steel)	
1 Pc Extension Rod (1" x 2" Carbon Steel)	
1 Pc Extension Rod (1" x 4" Carbon Steel)	
2 Pc Main Rod (8" x 1.75p Carbon Steel)	
2 Pc Extension Rod (8" x 1.75p Carbon Steel)	
1 Pc Beam (Carbon Steel)	
1 Set Bearing Separator & Bolts (Capacity 75mm - 105mm) Bolt 5/8" x 18t Capacity 105mm Carbon Steel.	
1 Pc Nut (Ram Part SCM21 415 Hardened 42° ~ 45°)	
For Agriculture, Machine, Garage and Industry Use	

JOA102 AE310095	4t Hydraulic Puller	
Capacity	4t	
Reach (mm)	A	185/250
	B	70
Spread (mm)	C	75/55
	D	255/110
Stroke (mm)	H	60
Pump Tip (mm)	E	42
	F	22
	G	84
Jaw Tip (mm)	A	11
	B	6
	C	22
	I	32
Net Weight (kg)	4.5/8.5	



JOA104 AE310021	Outer Tie Rod Remover
Leg. 7" 2 piece (SCM420) Hardened 42°	
Centre Bolt: (SCM420) Hardened 42°	
Centre Connector: (SCM420) Hardened 42°	

JOA103 AE310011	Gear Puller Set
1 Pc Beam, Carbon Steel	
1 Pc Central Bolt, 18.65mm x l 11.5" x 10t	
1 Pc Nut, Carbon Steel	
1 Set Bearing separator & bolt (SCM 415 drop forged hardened 42° ~ 45°, Capacity 70 - 105mm)	
2 Pc Main Rod (8" x 1.75p, Carbon Steel)	
2 Pc Extension Rod (8" x 1.75p, Carbon Steel)	

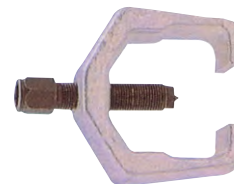
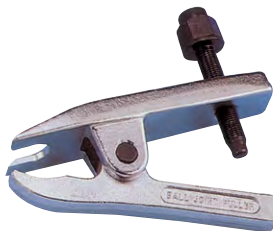

JOA106 AE310023	Ball Joint Puller
SCM-4140 Hardened 45°	
Bolt: SCM-4140 Hardened 45°	
Centre Connector : SCM-4140 Hardened 45°	

JOA105 AE310022	Pitman Arm Puller
Pitman Arm Puller (SCM415) Hardened 42°-43°	
Centre Bolt: (S45C Carbon Steel) Hardened 42°-43°	

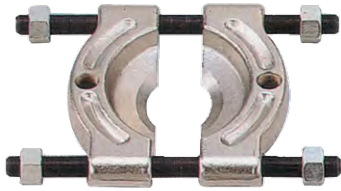

JOA107 AE310025	Bearing Separator 50mm x 75mm
SCM415 Hardened 42°-45°	
Capacity 2 1/4" - 3 1/2" (50mm x 75mm)	
Bolt Ø 12.7mm x l 135mm x 1/2" x 20t	

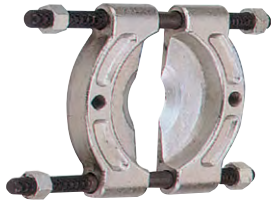

JOA109 AE310027	Bearing Separator 105mm x 150mm
SCM415 Hardened 42°-45°	
Capacity 4" - 6" (105mm x 150mm)	
Bolt Ø 19mm x l 260mm x 3/4" x 16t	

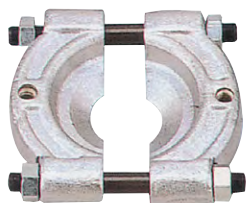

JOA108 AE310026	Bearing Separator 75mm x 105mm
SCM415 Hardened 42°-45°	
Capacity 3" - 4 1/2" (75mm x 105mm)	
Bolt Ø 16mm x l 165mm x 5/8" x 18t	

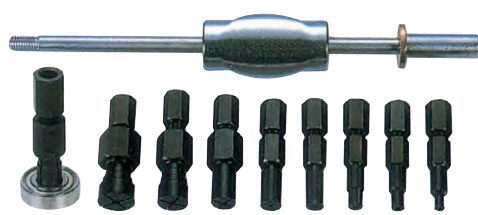

JOA204 AE310082	Bearing Hole Puller Kit
Slide Hammer Shaft 390mm	
Bearing Hole puller - 8, 10, 12, 15, 17, 20, 25, 30mm	
JOA204aa	Slide Shaft Hammer 390mm
JOA204ab	Bearing Hole Puller hammer
JOA204ac	Bearing Hole Puller 8mm
JOA204ad	Bearing Hole Puller 10mm
JOA204ae	Bearing Hole Puller 12mm
JOA204af	Bearing Hole Puller 15mm
JOA204ag	Bearing Hole Puller 17mm
JOA204ah	Bearing Hole Puller 20mm
JOA204ai	Bearing Hole Puller 25mm
JOA204aj	Bearing Hole Puller 30mm



JOA1114 / 1116 / 1118 AE310035 / 36 / 37		3 - Jaw Gear Puller			
Code	Part No.	Size	Weight	Cuft	Capacity (tons)
JOA1114	AE310035	4"	23.5/ 24.5 kg	1.2'	5
JOA1116	AE310036	6"	29.5/ 30.5 kg	1.7'	7
JOA1118	AE310037	8"	19/20 kg	1.1'	12

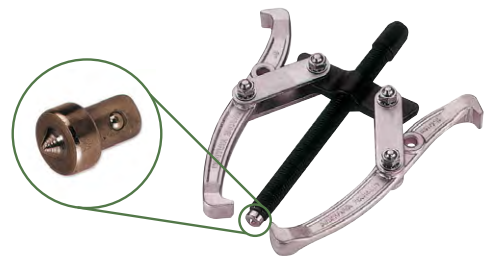

JOA1104 / 1106 / 1108 AE310030 / 31 / 32		2 - Jaw Gear Puller			
Code	Part No.	Size	Weight	Cuft	Capacity (tons)
JOA1104	AE310030	4"	24/25 kg	1.13'	3.5
JOA1106	AE310031	6"	22.5/ 23.5 kg	1.2'	5
JOA1108	AE310032	8"	24/25 kg	1.5'	8



JOA825 AE310068	FWD Front Wheel Bearing Adapter Set
Remove and replace front wheel bearing with the steering knuckle and strut assembly still on the vehicle! Eliminates the need for front end alignment after the service work has been done. Use with a slide hammer and front hub puller. Works on both domestic and import front wheel drive cars and light trucks.	



BODY TOOLS



JOA001
AG010140 Multi Dolly



JOA002
AG010030A2 Double End Hand Dolly



JOA003
AG010030A1 Curved Dolly



JOA004
AG010030A4 Toe Dolly



JOA005
AG010030A Auto Repair Tool Set 6 Pc

CONTENTS:	
AG010030A-2	1 Pc Double End Hand Dolly
AG010030A-3	1 Pc Drip Moulding Spoon
AG010030A-1	1 Pc Curved Dolly
AG010030A-4	1 Pc Toe Dolly
M10110	1 Pc Pick & Finish Hammer
M10401B	1 Pc Light Shrinking Hammer (Flat Face)



JOA114
AE310005 10 lbs 9 Pc Dent Puller Set

1 Pc Pipe (Ø 22.5mm x l 590mm)
1 Pc Hammer (10lbs Cast Iron)
1 Pc Pipe (Ø 22.5mm x 200mm)
1 Pc Plate (6mm x 170mm)
1 Pc Plate (6mm x 120mm)
1 Pc Plate (6mm x 120mm)
1 Pc Plate (6mm x 200mm)
1 Pc Plate (3mm x 100mm)
1 Pc Two Hope Pipe (Ø 29 x 40mm)
1 Pc Chain & Hook
1 Pc Hex Nut (29mm)



JOA200
AE010020 4t Portable Power Kit

Part No	Description	Qty
AE010020-01	Hydraulic Hand Pump 400 CC	1
AE010020-02	Jack Hose ¼" x 2W x 10000psi	1
AE010020-03	4t Ram (4" Stroke) (CR-MO)	1
AE010020-04	Spreader Ram (500 kg)	1
AE010020-05	420mm Extension Tube	1
AE010020-06	190mm Extension Tube	1
AE010020-07	150mm Extension Tube	1
AE010020-08	85mm Extension Tube	1
AE010020-09	Male Connector	1
AE010020-10	Flat Base	1
AE010020-11	90° "V" Base	1
AE010020-12	Wedge Head	1
AE010020-13	Spreader Plunger Toe	1
AE010020-14	Spreader Ram Toe	1
AE010020-15	Flex Head	1
AE010020-16	Serrated Saddle	1

Automotive Range

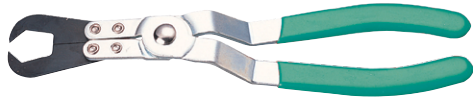

**JOA300
AB030015** **Windshield Moulding/Door Handle Clip Pliers**

For removing most windshield moulding clips and door handle clips. Releases clips to remove chrome moulding on most windshields and rear glass. Offset handle permits easy access to moulding clips. Slips under door handle without damage to panel.



**JOA400
AG010020** **Hand Sander Wooden Handle**

Sand Paper Size: 2 3/4" x 17"

Base Length: 15 3/4"



**JOA301
AB030022** **10 in 1 Trim Tool**

Made with tempered spring steel and a handle coated with heavy duty plastic, this tool offers:

1. Moulding remover semi sharp beveled edge for removing protector moulds and badges retained by 2v sides tape preventing scratching.
2. Windshield wiper wrench
3. Door rubber metal clip inserter
4. Door weather strip clip remover
5. Door trim-bezel clip remover
6. Door handle clip remover
7. Headlamp spring tool
8. Windshield moulding clip remover
9. Door rubber plastic clip remover
10. Serrated edge for panel seam clean up



**JOA401
AG010023** **Sanding Block**

Size: (w)106mm x (l)212mm

ABS Plastic body



**JOA402
M10110** **Pick Hammer**

Crowned Face



**JOA304
AB030043** **Door Upholstery Remover "V"**

For plastic upholstery fasteners. Place tool under edge of door panel and insert into fastener and then simply pry up.



**JOA403
M10210B** **Straight Peen & Finishing Hammer**

Crowned Face



**JOA306
AB030049** **Trim Remover Tool**



**JOA502
AE180001** **Door Opening Holder Set**

Length: 74cm - 115cm

Length can be adjusted by way of a screw action using the pin provided.



**JOA404
M10410A** **Heavy Shrinking Hammer (Flat Face)**

Milled Face



**JOA450
M10110-H** **Hickory Handles**



JOA205 AE10010A		10t Portable Power Kit
Part No	Description	Qty
AE10010-01	Hydraulic Hand Pump 700 CC	1
AE10010-02	Jack Hose ¼"x2Wx10000psi	1
AE10010-03	10t Ram (10" Stroke) (CR-MO)	1
AE10010-04	Spreader Ram (500 kg)	1
AE10010-05	450mm Extension Tube	1
AE10010-06	320mm Extension Tube	1
AE10010-07	260mm Extension Tube	1
AE10010-08	130mm Extension Tube	1
AE10010-09	Male Connector	1
AE10010-10	Flat Base	1
AE10010-11	90°"V" Base	1
AE10010-12	Wedge Head	1
AE10010-13	Spreader Plunger Toe	1
AE10010-14	Spreader Ram Toe	1
AE10010-15	Flex Head	1
AE10010-16	Serrated Saddle	1



E D C B A

JOA305 AB010026S		Trim Remover Set
Contents:		
AB010026A : Wedge Set		
AB010026B : Wedge Set		
AB010026C : Handy Remover		
AB010026D : Remover Wide Type		
AB010026E : Remover Pull Type		



JOA006 AG010024		Speed File
Curved Tooth Holder / File Holder		
Holds 350mm flat, flexible file only		
Adjustable frame		



JOA006a AG010024-1		Speed File Blade 9TPI
-----------------------	--	-----------------------

JOA006b AG010024-2		Speed File Blade 12TPI
-----------------------	--	------------------------



JOA007 MF05S		5 Piece, 8" File Set
Comfortable ergonomic handle design		
Handle manufactured from thermal plastic elastomen ensures firm grip		
Resistant to acid, fluids and solvents		
Carbon steel with rust prevention coating		



JOA700 AI010016		Tail Pipe Reshaper
Services both large and small diameter exhaust and tailpipes		
Designed to shape pipes ranging in diameter from 1-5/8" to 3-1/16"		



JOA405 AG010116	Long Internal Snap Ring Pliers
----------------------------------	---------------------------------------



JOA607 AR060003	Swivel Jaw Hose Clamp Pliers
"V" slot	
For easy removal & installation of ring type hose clamps.	
Jaws swivel to grip any angle	



JOA708 A1040006	Lock Ring Pliers (Straight tip)
Removing and installing all types of lock rings.	
Used in brakes, transmission, pedal shafts, clutch shafts.	
Deep serrated jaws hold lock rings securely.	



JOA720 A1040005	Lock Ring Pliers (Angle Tip)
Removing and installing all types of lock rings.	
Used in brakes, transmission, pedal shafts, clutches shaft.	
Deep serration jaws hold lock rings securely	



JOA415 – JOA416 AG010002 – AG010003	Straight Nose, Internal Circlip Pliers
JOA415 (AG010002)	7" (175mm)
JOA416 (AG010003)	9" (230mm)



JOA419 – JOA420 AG010008 – AG010009	Straight Nose, External Circlip Pliers
JOA419 (AG010008)	7" (175mm)
JOA420 (AG010009)	9" (230mm)



JOA421 – JOA422 AG010011- AG010012	Bent Nose, External Circlip Pliers
JOA421 (AG010011)	7" (175mm)
JOA422 (AG010012)	9" (230mm)



JOA417 – JOA418 AG010005 – AG010006	Bent Nose, Internal Circlip Pliers
JOA417 (AG010005)	7" (175mm)
JOA418 (AG010006)	9" (230mm)

GENERAL TOOLS

Automotive Range



JOA307
AG010190B Flexible Magnetic Pick-up tool
525mm



JOA406
AG010034 Magnetic Pick-up Tool
Heavy Duty Pocket Size
Capacity: 3.5 lbs l: 580mm



JOA407
AG010032 Telescoping Inspection
Mirror 580mm



JOA431
AG010033 Telescoping Inspection
Mirror 50 x 92mm
50 x 92mm



JOA430
AI030025(B) 2Pc "O" Ring and Hook
scribe set
A great variety of uses including scribing metal, picking "O" rings from grooves, retrieving parts from hard to reach areas.
1Pc - Combination Hook Pick
1Pc - 90 Degree Straight Pick



JOA413
AG010059 4 Pc Stud Puller Wrench Set
(Metric)
Chrome Vanadium Steel
Metric Size: 6mm; 8mm; 10mm; 12mm

Available individually:
JOA41306 (AG010061-6) - 1/2" Dr. 6mm Stud Puller Wrench
JOA41308 (AG010061-8) - 1/2" Dr. 8mm Stud Puller Wrench
JOA41310 (AG010061-10) - 1/2" Dr. 10mm Stud Puller Wrench
JOA41312 (AG010061-12) - 1/2" Dr. 12mm Stud Puller Wrench



JOA432
AG010061 7Pc Stud Puller Wrench Set
Excellent to use with screws without heads. Quick operation without any damage to the stud. Just put the stud puller wrench on a screw, then add the handle and turn in desired direction.
Size: 5, 6, 7, 8, 10, 12, 14mm
Warning:
Use torque range no more than:
5mm - 15Ft/Lbs (20NM) 10mm - 15Ft/Lbs (33NM)
6mm - 15Ft/Lbs (20NM) 12mm - 15Ft/Lbs (33NM)
8mm - 15Ft/Lbs (20NM) 14mm - 15Ft/Lbs (33NM)



JOA428
AI030027 6 Pc Pick and Hook Set
Straight, hook, combination.
Cotter key puller.
45 & 90 degree large pick & hook.
Organisational tray.
Advanced tri-lobal ergonomic design handle increases torque and provides comfort while reducing fatigue.
TPE (Thermal Plastic Elastomer) over-mold ensures firm grip.
Resistant to acids, fluids and solvents.
Extra Long 18" shaft for added reach.
Large 5/16" (8mm) shaft diameter for added strength.
Chrome-Vanadium steel shafts with high-polished chrome plated finish.



JOA410 AG010089	Digital Tyre Pressure Gauge
Specifications:	
Long Life Lithium Battery	
Metal Valve Stem for Durability	
Large Easy to Read Liquid Crystal	
Simple One button Operation	
Self calibrating	
Accurate from 3-100psi +/- 1 psi at 75°F	
Visual cue upon Completion of Measurement	
Auto LCD Power Off	
High Impact AVS Design	
Replaceable Battery	
Patent	

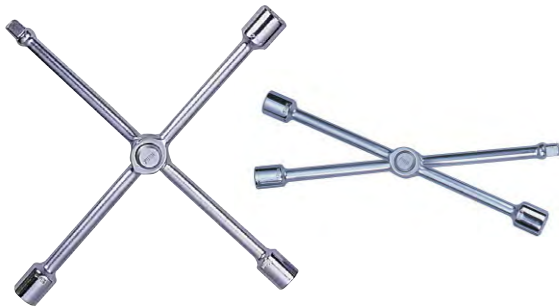

JOA414 AG010098	14" Push & Foldable Cross-Handle Socket Wrench
Mat Finish	
Socket Size: 17,19,21mm	
1/2" Square Dr.	
Wheel Spanner	

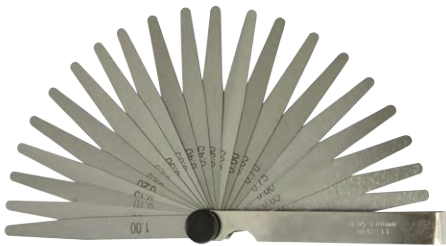

JOA426 AI060020	Feeler Gauge 20 Blade (0.05-1mm)
0.05, 0.1, 0.15, 0.2, 0.25, 0.3, 0.35, 0.4, 0.45, 0.5, 0.55, 0.6, 0.65, 0.7, 0.75, 0.8, 0.85, 0.9, 0.95, 1mm	



JOA411 AG010110	7 Pc Screw Extractor and Nap Set
3/8" Tap Hand	
Size: 1/8"; 1/4"; 5/16"; 7/16"; 9/16"	



JOA409 AG010038	Professional 3 Function Tyre Gauge
----------------------------------	---



JOA425 AG010138	1/2" Dr. Impact Driver
Star	1,2,3,4,
Slotted	5,6,8,10,12
Hex Key	4,5,6,8
13Pc Bits Set individually available. (JOA425b)	

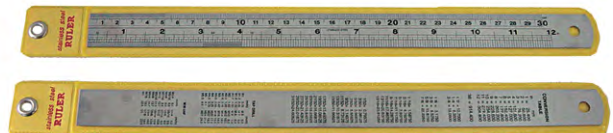

JOA427 MTC112	Stainless Steel Ruler (300mm / 12")
--------------------------------	--



JOA424 AH020002	Fender Cover 1050 x 650mm
Magnetic design to install and remove easily.	

GARAGE WORKSHOP TOOLS

Automotive Range



JOA500 AE300103	Waste Oil Storage
Capacity: 16l	
Size: 600x450x180mm	
Weight: 1.05 kg	



JOA818 AN040043A	Tubing Cutter and Double Flaring Tool Kit
Includes heavy duty tube cutter, standard 45° flaring tool and double flaring adapters set in custom carrying case.	
Metric flaring, double flaring & cutting tool set flares in seven metric sizes: 4; 6; 8; 10; 12; 15 & 16mm	
Five double flaring adapters cover 4; 6; 8; 10 & 12mm tubing	



JOA712 AI050024	4 Pc Pry Bar Set
CONTENTS:	
JOA712a	17/16" x 24"
JOA712b	3/8" x 12"
JOA712c	1/4" x 8"
JOA712d	7/16" x 18"



JOA821 AN040035A	Telescopic Tubing Cutter
Aluminium body	
SUJ2 Cutting wheel	
Capacity: 1/8" - 1 1/8"	



JOA423 AG010037	Rectangular Magnetic Tray (240 x 140mm)
----------------------------	--



JOA408 AG010036	150mm Spare Parts Magnetic Dish
----------------------------	--



JOA602 AR020016	Digital Automotive Analyser & Multi Meter
Function:	
r.p.m., Dwell, Volts DC, Volts AC, Amps DC, Resistance, Duty Cycle, Temperature, Pulse Width, Frequency, Diode Test, Audible Continuity, Battery Test	



JOA604 AR030007	Car Battery & Alternator Checker
LED lights indicate car battery condition (engine stop) or output of alternator (engine running)	
Lights show poor, fair or good condition	
Magnetic back board keeps your hands free for checking	



**JOA600
AR020001** **Timing Light with Tach/Dwell/
Volt Tester**

Heavy chrome plated die cast metal housing with protective rubber nose.
Works on all 12 volt gasoline engines.
Detachable heavy duty inductive pick up clamps and leads for easy operation and replacement.
Bright xenon flash tube provides concentrated light visibility of timing mark.

Functions:	
Tach:	0-3000 r.p.m. (4 cylinder) 0-2000 r.p.m. (6 cylinder) 0-1500 r.p.m. (8 cylinder)
Dwell:	0-90 Degree (4 cylinder) 0-60 Degree (6 cylinder) 0-45 Degree (8 cylinder)
Volt:	0-16V



**JOA616
AR030003** **Heavy Duty Circuit Tester**

- Checks Voltage 6-12-24 V System
- 5-ft Cable with spring relief.
- Tough plastic handle lights up if circuit is good.
- Heavy duty insulated alligator clip.



**JOA606
AR040019** **Metal Case Battery Brush
(Nickel Plated)**



**JOA605
AR030013** **Battery Hydrometer**

Glass type, does not fade.



**JOA601
AR020006** **Digital Advance Timing Light
with Tach/Dwell/Volt Tester**

Professional quality tool works with conventional and distributor-less (DIS) ignition systems.
Large LED makes readings easy.
Works on all 12 volt gasoline engines.
High impact ABS housing.
Detachable heavy duty inductive pick-up clamps and leads for easy operation and replacement.
Bright xenon flash tube provides concentrated light for easy visibility of timing mark.

Functions:	
Advance:	0-60 Degree BTDC
Tach:	200-10000 r.p.m.
Dwell:	0-99.9%
Volt:	0-16V



**JOA603
AR030004** **Heavy Duty Circuit
Tester**

The best quality electrical tester available for checking 6 and 12 volt systems. Made to last a life time.
Has heavy duty ground clip and insulator, 5' of tough flexible rubber wire is retained in spring supported strain relief designed to withstand the most rugged use. Bulb is easily replaced.



**JOA612
MTC150** **6" Electronic Vernier Caliper
(150mm)**

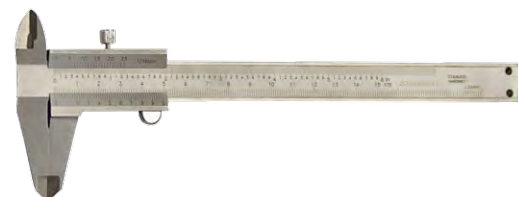

**JOA617
MTC1150** **Vernier Caliper Stainless Steel
(150mm)**

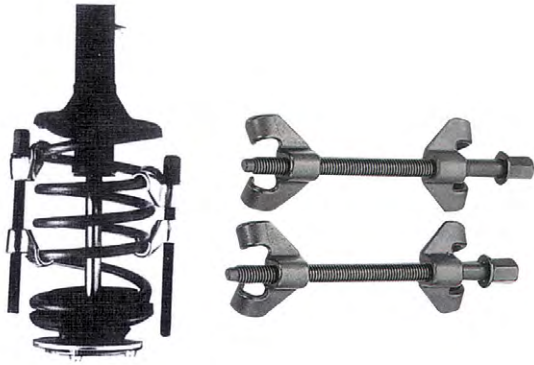

JOA113 AE320023	Heavy Duty Coil Spring Compressor
Maximum Jaw Opening	270 mm
Drop forged, CR-MO and heat treated to ensure a professional job	
Can be used with air impact wrench	
The tool is designed for use in limited space under wheel arch	
Jaw is designed to wrap coil claws for safety	



JOA827 AI060031	87Pc Threaded Coil-Insert Repair Kit
----------------------------------	---



JOA817 AN040062	MAN, BENZ Truck Diesel Injection Valve Socket
The tool to remove and install diesel injection valves. Application: Man (422.403) BENZ Truck.	

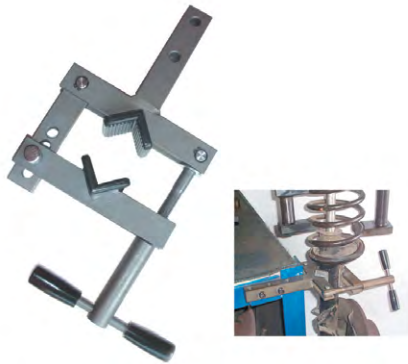

JOA203 AE320035	Vice for Shock Absorbers
Attaching the pipe vice to the workbench allows repairs to be carried out quickly and cleanly.	
Struts should never be held in a normal workshop vice due to the risk of deforming the strut tube.	



JOA701 AI010023	Fan Belt Tightener
Makes belt tightening easier	
One person job. Works on most alternators and some other belt driven accessory units	
Loosens adjusting slot bolts	
Hook the tool around the alternator – locking it on the pivot bolt boss or on any other strong protrusion	
Pull to proper belt tension with a 1/2" square drive socket handle. Tighten the adjusting slot bolt while holding this tension	



JOA610 AR060015	7 Pc Disconnect Set
Includes six tools for disconnecting spring couplings on Ford, GM, and Chrysler air conditioning lines. Also works on fuel lines and can be used as push lock connectors on radiator and transmission lines.	



JOA802 AN010038	Professional Seal Puller
----------------------------------	---------------------------------



JOA726 AI050042	2 Way Viscous Fan Spanner 32mm & 36mm
For the removal of thermo-viscous fans on BMW, OPEL vehicles	



JOA501 AE300095	Radiator Pressure Tester
Detects leaks in car radiators	
Offers professional service quality and easy operation	
Conforms to every kind of car radiator's opening diameter & high quality of full set accessories	
The main body uses POM plastic steel material.	



JOA308 AE300193	Universal Radiator Pressure Tester Adaptor
Suitable for universal vehicle radiators: Buick, Chrysler, Chevrolet, Dodge, Jeep, Benz, Ford, GM, Honda, Hyundai, Infinity, Kia, Lexus, Mazda, Mercury, Mitsubishi, Toyota, BMW, Audi, VW.	



JOA804 AN010064	Overhead Valve Spring Compressor
For use on a wide range of OHV, OHC and CVH engines. Not suitable for use on engines with deep seated valves. Allows valve springs and valve stem oil seals to be replaced with the cylinder head. Features a reversible jaw/adaptor and automatic cam-action locking to a pre-determined setting.	



JOA707 AI020049	Universal Overhead Cam Valve Spring Compressor
For use on most foreign and domestic engines, including AUDI, CHRYSLER, INFINITI, HONDA, HYUNDAI, LEXUS, MAZDA, MITSUBISHI, NISSAN, PORSCHE, SATURN, TOYOTA, VOLVO and VOLKSWAGEN.	
This kit includes everything you need to remove and install the valve spring with the cylinder head on or off the OHV and OHC petrol or diesel engine. An ideal tool kit for most foreign and domestic engines. The multi-point adjustable base of this tool bolted securely to the head while the adjustable lever mechanism pivots from the beam thus compressing the spring quickly by one hand operation, fast removal and installation of the spring retaining keepers is easily accomplished by hand through the large opening on both sides of the compressing tube. This kit allows on the car servicing.	



JOA202 AE320034	McPherson Spring Damper Extractor
Spring compressors are multi-application tools.	
Developed for modern McPherson suspension.	
Application: BMW, TOYOTA, FORD	



JOA711 AI050057	Oil Filter Wrench (Strap)
1/2" Square Drive.	
Suitable for filter up to 120mm diameter.	



JOA710 AI050001	Oil Filter Wrench 3 Leg, 2 Way
3 Leg 2 Way size: 65mm to 120mm, (2-15/16" to 4-3/4")	
3/8" Square Drive with 19mm male hexagon adapter.	



JOA820a - JOA820b AN010009a-AN010009b	Plug Key (metric) & Sump Plug Key (Imperial)
Size: 15,14,13,12,11,10,17-14mm	
Length: 150mm	
Size: 3/4", 5/8", 9/16", 1/2", 7/16", 3/8", 9/16", 1/4"-7/16", 1/8"-1/4"	
Length: 8-1/4"	



JOA721 AN010159	Exhaust Spring Clamp Remover / Installer
Essential for safe, controlled removal of clamps which attach the exhaust to the manifold.	
Special design provides "leverage" required to expand the strong spring clamps	



JOA811 AN040071	VW T4 Front Axle Upper Ball Joint Installer/Remover
----------------------------------	--



JOT468 AI010090	13 Pc 1/2" Dr. Alternator Insert Bit Socket Set
1 Pc - Spline Alternator Combination Bit Socket, Size: M10, 110mm(L)	
1 Pc - Torx-star Alternator Combination Bit Socket, Size: T50, 110mm(L)	
2 Pc - Spline Bit, Length: 75mm, Size: M8, M10	
2 Pc - Torx-Star Bit, Length: 75mm, Size: T40, T50	
2 Pc - Hex Bit, Length: 75mm, Size: 8, 10mm	
1 Pc - 33Teeth Alternator Nut with 17mm Hex Tip	
1 Pc - 33Teeth Alternator Nut with 22mm Hex Tip	
1 Pc - Hex Alternator Nut, Size: 22mm	
1 Pc - 4 Points Alternator Nut with 17mm Hex Tip	
1 Pc - 1/2" Square Driver x 10mm Hex Bit Holder	

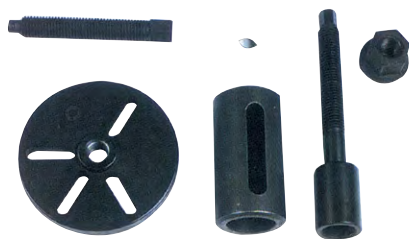

JOA815 AN010126	BMW Hub Remover/Installer
Designed for professional removal and installation of rear wheel hub. Applicable : E34.	



JOA716 AI050004A		Stud Oil Filter Wrench 30 Pc		
ItemNo	Article	Size	Flutes	Suitable For Motor Car
JOA716666	HC-66/6	66 (2-19/32")	6	Fiat (Punto, 1'-2) Renault (Clio 1.2 Express, Kangoo, Rapid, Twingo)
JOA7166814	HC-68/14	68 (2-11/16")	14	Fits Hastings, Mazda, Ford Escort, Capri, Subaru, Fran PH6607 (those Fram filters made in Korea) Motorcraft FL816
JOA7167314	HC-73/14	73 (2-7/8")	14	Fits Toyota / Lexus
JOA7167612	HC-76/12	76 (3")	12	Fiat, (z.b. Ducator, Scudo, Ulysee), Renault (Megane, Laguna. Espace 3)
JOA7167614	HC-76/14	76 (3")	14	Fits Champion, Champ Lee, Purolator, Mopar, VW, Porche, Mercedes Benz, BMW, Audi (I.B. A3TD) Opel.
JOA7167630	HC-76/30	76 (3")	30	Fits Motorcraft only FL400A, Ford
JOA716768	HC-76/8	76 (3")	8	Fiat (z.b. Marea), Lancia (z.b. Delta)
JOA7168015	HC-80/15	80 (3-9/64")	15	Fits Hastings, Fram, Purolator, Nissan, Honda, Motorcraft, Mazda, Isuzu, Subaru, Opel, Toyota.
JOA7168616	HC-86/16	86 (3-3/8")	16	Volvo (S40, S60, S70, S80)
JOA7168618	HC-86/18	86 (3-3/8")	18	VW Golf, (MK3, Tdi, passat Tdi.) Audi A6 Tdi, Renault (Clio, Rapid 1.9D Laguna, Safrane, Espace 2.1D) Citroen, Peugeot, Renault.
JOA7169015	HC-90/15	90 (3-17/32")	15	Fits Honda Accord, Mitsubishi, Mopar. Isuzu.
JOA7169210	HC-92/10	92 (3-40/64")	10	Fiat, Cinquecento, Coupe, Croma, Fiat, Panda, REgata, Ritmo Fiat, Seicento, Tempra, Tipo, Lancia (Beta. Dedra, Kappa, Monte Carlo, Prisma, Thema, Trevi)
JOA7169315	HC93/15	93 (3-21/32")	15	Fits Casite, Champ, Champion, GM, Fram, Hastings, Opel, Mazda, Volvo, Mitsubishi, Purolator, Wix, Nissan, VW, Porsche, Renault, Ford, Honda, Audi.
JOA7169345	HC93/45	93 (3-21/32")	45	VW-Audi, (Tdi 2.4, 2.6, 2.8L)
JOA7169515	HC-95/15	95 (3-6/8")	15	Toyota #15600-41010, Alfa, GM, Ford, ALFA, Chrysler
JOA7169618	HC-96/18	96 (3-3/4")	18	Audi (A4, A6, Tdi), VW, (Passat 97 Tdi) Renault (Laguna 2.2d, Safrane 2.2D Espace 2.2D, R10, Rapid, Megane 1.9/2 1D Tdi)
JOA71610015	HC-100/15	100 (4")	15	Fits Fram, Motorcraft, Wix, Isuzu and Mitsubishi.
JOA71610615	HC106/15	106 (4-11/64")	15	Fiat (Ducato 2.5D, Tdi)
JOA71610815	HC-108/15	108 (4-8/32")	15	Volvo (C70, S70, V70, Tdi. TD) (Turbo Diesel, 850 Tdi, Diesel) etc.
JOA71610818	HC-108/18	108 (4-8/32")	18	Renault (Espace, Laguna, Master, Safrane, Traffic 2.4, 2.5, 2.8D, TD)
JOA7166567	HC-65/67	65 to 67mm (2-9/16" to 2-21/32")	14	Fits same filters as made in Canada including PH4386, PH4967, PH6017, PH6018 Daihatsu.
JOA7167415	HC-74/15	74mm (3-29/32")	15	MF, Audi, #056-115-561G, GM, Rover, Chrysler.
JOA7167476	HC-74/76	74 to 76mm (3-29/32" to 3")	15	Fits Fram, Ac, Saturn
JOA7167577	HC-75/77	75 to 77mm (3-15/16" to 3-1/32")	15	Fits VW, Audi, Castie, GM/AC, Hastings, Wix, NAPA Ford, Isuzu, Mercedes, Opel
JOA7167815	HC-78/15	78mm (3-2/32")	15	Nissan #15208h8991, Ford, Toyota, Accord
JOA7168082	HC-80/82	80 to 82 (3-9/64" to 3-7/32")	15	Fits Wix filters branded for Mazda, Subaru, Toyota, Honda, Acura, Nissan, NAPA
JOA7169336	HC-93/36	93mm (3-21/32")	36	Fits Motorcraft only FL1A, FLA1B, FL300, FL820, Ford
JOA7166514	HC-65/14	Cup-type Oil Filter Wrench 14		
JOA716a	HC-65103	Two Way Oil Filter Wrench 65 – 120mm		
JOA716b	HC-9.5mm	Adaptor ½" (F) or 3/8" (M) Square Drive Tool		

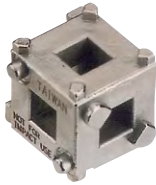

JOA800 AN010007	Disc Brake Piston "Cube"
Unique "Cube" design provides five drive pin configurations to fit most applications.	
Use with 3/8" drive tools.	



JOA801 AN010037	Brake Spring Compressor
Zinc plated to resist corrosion.	
Tough, easy grip with aluminium handle.	
Remove and install backing plate spring, cups & pins.	



JOA709 AI040008	Vacuum Testing/ Brake Bleeding Kit
The kit includes the vacuum pump, complete fittings and accessories for vacuum testing and brake bleeding, plus a detailed owners manual. The vacuum pump is field repairable. Replace worn "o" rings, seals and valves with the vacuum pump repair kit.	



JOA725 AI020064A	Fuel Injection Test Kit		
QTY	Description	QTY	Description
1	1/4"x 1/4" pipe plug	1	13" Ford Adaptor Hose
2	5/16"x1/4" NPT hose barb	1	Bleed off hose
2	1/4"x 1/4" NPT hose barb	1	Bosch C.I.S Hose
1	0-50 psi (0-3.5 bar) gauge	1	Basic Hose 24"
1	0-100 psi (0-7 bar) gauge	1	8mm-1.0 banjo bolt adaptor
4	Hose Clamps	1	10mm-1.0 banjo bolt adaptor
1	5/16" Hose	1	12mm-1.25 banjo bolt adaptor
1	1/4" Hose	1	10mm-1.50 banjo bolt adaptor
1	Ford Spring Lock Adaptor	1	Honda Adaptor
1	1/4" NPT tee with valve	1	12mm-1.50 male x 10mm-1.00 female x 1-1/4" adaptor
1	G.T.T.B.I. adaptor	1	12mm-1.50 male x 10mm-1.00 female x 1-1/4" adaptor
1	G.M quick connect adaptor	1	12mm-1.50mm male x 8mm-1.00 female x 5/16" adaptor
1	G.M 2.2L adaptor	2	12mm-1.50 male x 8mm-1.00 male adapter
1	Ford hair pin adaptor	1	12mm-1.50 male x 8mm-1.00 male x 3" adapter

JOA824 AN010001B	13 Pc Caliper Wind Back Tool
Services: Mercedes, BMW, VW, GM, Audi, Ford, Honda, Subaru, Mazda, Nissan, Mitsubishi, Toyota, Renault & Opel	



JOA706 AI020052	Petrol Engine Compression Tester Kit
Compression Tester – General Purpose M14 & M18 Plug Ports, M14 & M18 Thread Chaser, M10 & M12 Thread Chaser, M10 Extension, M12 Extension, M14 Extension, M18 Extension, Service Kit	
For use on cars, vans and motorcycles this comprehensive kit is based on petrol compression tester for vehicles with M10, M12, M14 and M18 spark plug threads. Complete with extensions, thread chasers and service kit.	
Easy to use.	
Checks condition of valves, piston rings, gaskets & cylinder heads.	
Pressure relief valve enables repeated testing of a cylinder without removing the gauge.	



JOA717 AI020054	Oil Pressure Tester Set
Gauge Assembly: Overall Length = 1300mm Gauge Diameter = 80mm Scale = 0-10 bar Adaptors: Thread, R1/8 DIN 2999, 1/8 X 27 NPT, 1/4 X 18 NPT, 3/8 X 20 UNF, 1/2 X 20 UNF, M10 X 1.0, M12 X 1.5, M14 X 1.5, M16 X 1.5, M18 X 1.5, 90° Elbow.	
Helps to diagnose worn oil pumps and engines, faulty oil pressure switches and warning indicators. Easy to use. Accurately tests oil pump pressure, switch and warning indicators. Large clear dual scaled gauge. Quick coupling adapters with shut-off valve for speed and security. Permanently oil primed, long, flexible hose.	

JOA850 AI020051	Diesel Engine Compression Tester Set (Cars) mm		
Applications: BMW/MERCEDES BENZ/CARBODIES/MITSUBISHI/CITROEN/NISSAN/DACIA/OPEL/DIAHATSU/PEUGEOT/FIAT/RENAULT/FORD/ROVER/HOLDEN/SEAT/ISUZU/TOYOTA/LANDROVER/VAUZHALL/LEYLAND/DAF/VOLKSWAGEN/MAZDA/VOLVO			
Description	Overall Length	Gauge Diameter	Scale
Gauge Assembly	560	83 thread	0-60 bar outside diam.
Glowplug Adapter	73.5	M10x1.0	
Glowplug Adapter	54	M12x1.25	
Glowplug Adapter	72	M14x1.25	
Dummy Injector	114	n/a	21
Standyne Dummy	112	n/a	19
Glowplug Adapter	114.5	M10x1.0	
Glowplug Adapter	114.5	M10x1.0	
Dummy Injector	78	M20x1.5	
Replacement seal and washer set: 90 degree elbow			
	Length	Width	Hole
Clamp Plate	63.5	25	17
Simple and easy to use. Comprehensive test kit for both direct and indirect diesel injected cars. Checks engine compression under cranking conditions. Small profile, quick coupling adapters for speed and security. Built-in pressure relief valve enables repeat tests without dismantling. Dual scale 80mm dia gauge 0-1000 lb/in ² & 0-70 bar.			



JOA702 – JOA705 AI020048A – D	Piston Ring Compressors	
Code	Height	Capacity
JOA702	3 1/4"	2 1/4" – 5"
JOA703	4"	2 1/4" – 5"
JOA704	3 1/4"	3 1/2" – 7"
JOA705	4"	3 1/2" – 7"



JOA809 AN020003	Brake Cylinder Hone
3 Arm range 1 1/4" – 3 1/2" (32 – 89mm)	
Replacement stone.	
Stone size 2" (51mm)	

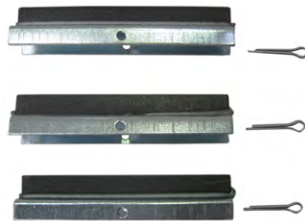

JOA80901 AN020003-1	Replacement Stones - JOA809
--------------------------------------	------------------------------------



JOA808 AN020001	Deluxe Brake Cylinder Hone
2 Arm range 1 1/16" – 2 1/2" (18-63mm)	
Replacement stone.	
Stone size 1 1/8" (28.8mm)	



JOA80801 AN020001-1	Replacement Stones - JOA808
--------------------------------------	------------------------------------



JOA727 A1020066	Piston Ring Compressor Kit
Installs pistons from 2-7/8" – 4-3/8" (73mm – 111mm)	
Ratcheting lock allows for bands to compress in small increments.	
Can be used in the following positions: parallel, vertical, perpendicular, horizontal	
Set includes pliers and six bands	



JOA728 A1010009	Piston Ring Groove Kit
Piston Ring Groove Cleaning	



JOA803 AN010072	External & Internal Restorer Files
Restore tool for renewing damaged thread on any diameter bolt, stud, axle or shaft file both right and left hand threads.	
Designed to use in hidden and narrow areas.	
Metric file 0.80,1.00,1.25,1.50,1.75,2.00,3.00	



JOA805 AN010072A	External Thread Restoring Files
Description	Pitch Sizes
Metric File	0.75,1.00,1.25,1.50,1.75,2.00,2.50,3.00



JOA807 AN010072C	External Thread Restoring Files
Description	Pitch Sizes
SAE File	9,10,12,16,20,27,28,32



JOA806 AN10072B	External Thread Restoring Files
Description	Pitch Sizes
SAE File	11,12,13,14,16,18,20,24



JOA724 AI010041	Petrol Engine Twin Cam Locking/Setting Tool & Flywheel Holding Tool Kit
Holds camshafts in place while replacing timing belts – suitable for twin cam.	
Suitable for range of vehicles including Ford, Honda, Land Rover, VW, Renault, Citroen, Peugeot, Fiat and Opel.	
Contents: 10 Pc Camshaft locking tool, 4 Pc Locking pins, 2 Pc Setting and Locking plate, TDC location pin and Flywheel holding pin.	



JOA723 AI010040	Universal Twin/4 Cam Lock (Gas & Diesel Engines)
Holds camshaft in place while replacing timing belts.	
Tool fits various diameters and tooth pitch.	



JOA719 AI020068	BMW Camshaft Alignment Tool Kit
BMW Engine models M42 & M50: includes 2 blocks swivel lock plate and locking pin for setting camshaft timing.	
Engine models M40 & M70: includes plate and locking pin for setting camshaft timing.	
BMW engine models M60 & M62: includes 2 blocks swivel lock plate and locking pin for setting camshaft timing.	



JOA718 AI010026	Benz Crankshaft Pulley Holder
Suitable for Benz M111 and M112	
Break loose the crank shaft pully / harmonic balancer bolt. Designed to properly secure the pulley from rotating during R&R of crank bolt. The 50mm hex head armature slips past the slightest of spaces and slides right into the center slot on the pulley. Then slide the long bar onto the receiving end of the armature and lock it into position with the securing bolt.	



JOA826 AN010008 Bearing Race & Seal Driver
Collars: 1.565", 1.750", 1.965", 2.325", 2.555", 2.470", 2.8230", 2.995", 3.180"
6 sizes fit most bearing race sizes #1 - #6
Inserts bearing race quickly. Helps reduce damage to both race & axle housing.



JOA823 AR060026 Dust Shield Kit



JOA822 AR060029 Dust Shield Installer



JOA812 AN040072 Benz (W140) Lower Control Arm Bush Remover/Installer



JOA814 AN010125 BMW Bush Extractor/Installer
Removal and replacement tool for metallic bushes on upper sub-frame. Applicable : E32, E34.



JOA816 AN010128 BMW Transmission Extractor/Installer
This set of tools is designed to extract and install BMW Thmr 1 transmissions



JOA611 AR060017 Rubber Spark Plug Remover and Installer
Flexible shaft permits access from many angles.
Flexible shaft to facilitate removal of hard to reach spark plugs



JOA713 AI040011	Spark Plug Boot Pliers
Safely remove spark plug cables and prevent cable damage. Pliers handles and jaws are coated with a heavy-duty plastic for a sure grip.	



JOA729 AI020056A	Valve Stem Seal Pliers (long)
For removing valve stem seals in multi-valves engines. Jaw longitudinal toothed avoids slipping down. For deeply leveled valve stem seals.	



JOA722 AN010161	Internal Lock Ring Pliers
Wide flat jaws designed for easy removal of lock rings on transmissions, differentials, shafts etc.	
98145.451	



JOA608 AR060008	CV Joint Boot Clamp Pliers
For ear type clamps	
Fits late model GM CV joint boots	
Also installs Perms-Quick type clamps quickly and easily	
Use for filter, cooling system and vacuum lines	



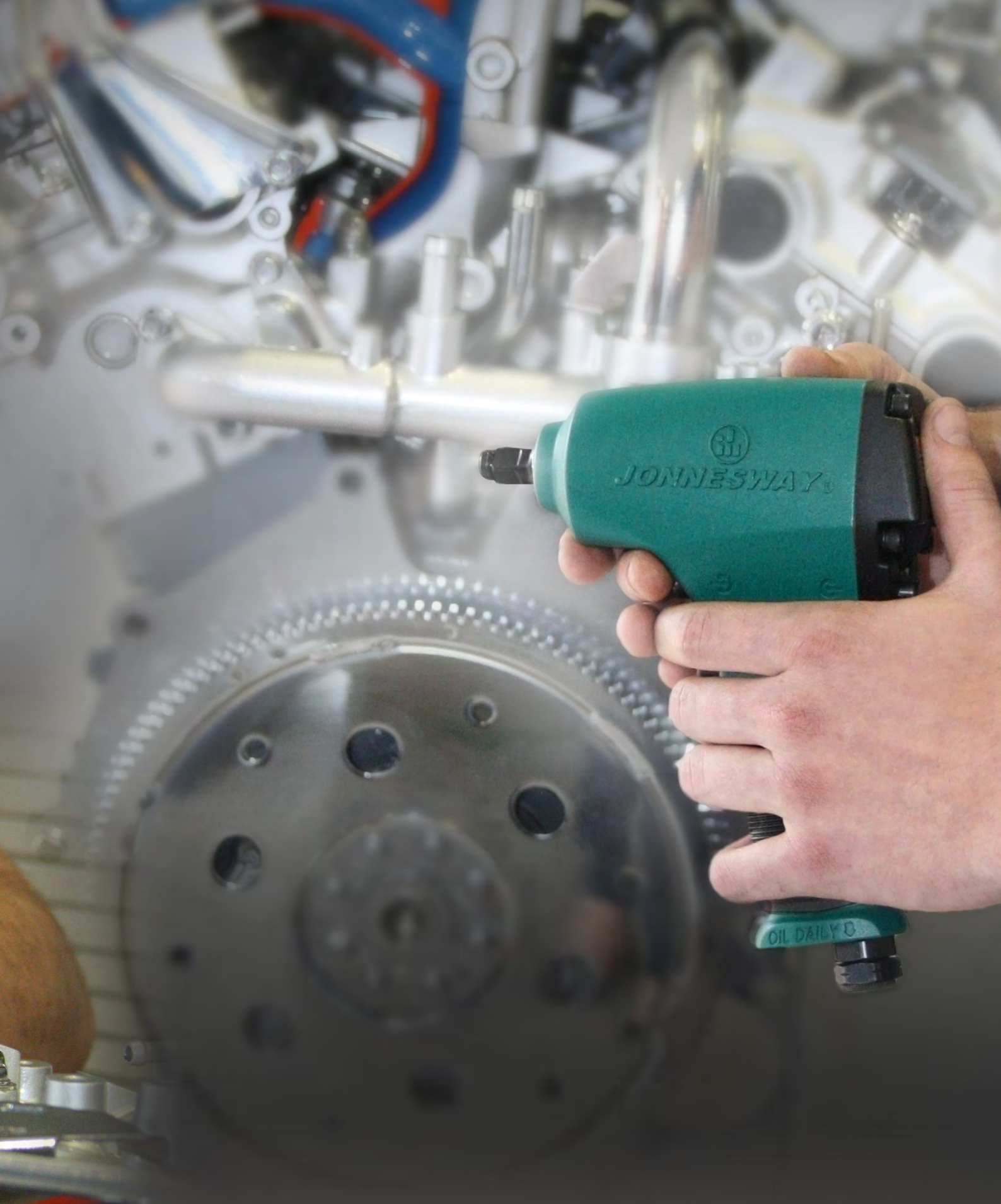

PNEUMATIC



COMPOSITE AIR IMPACT RANGE

The reliable twin hammer clutch system is extremely robust and delivers a stable torque with low vibration. The mechanism is made from high quality construction steel through a heat treated process that improves durability.



Forward / reverse switch and air inlet adjustment for easy operation.

A motor with superior precision increases output efficiency.

Ergonomic handle design improves operating comfort.

The composite housing and aluminium alloy motor design unit effectively reduces the weight of the unit, improving operating comfort.



PNEUMATIC POWER TOOLS

Pneumatics Range

JOP005 JAI-0924		1/2" Dr. Composite Air Impact Wrench	
Square Drive		1/2" (12.7mm)	
Max Torque	Ft-lb	550	
	Nm	746	
Working Torque	Ft-lb	510	
	Nm	681	
Free Speed	r.p.m.	8500	
Bolt Capacity	in	5/8	
	mm	16	
Length	in	7.52	
	mm	191	
Weight	lbs	4.27	
	kg	1.94	
Hose Size	in	3/8	
	mm	10	
Working Pressure	psi	6.3 kg/cm ²	
Air Inlet	in	1/4	
Clutch Mechanism		Twin Hammer	

JOP002 JAI-0926		3/4" Dr. Super Duty Impact Wrench with 2" Anvil	
Square Drive		3/4"	
Std Bolt Capacity		1"	M25
Free Speed (r.p.m.)		6500	
Max. Torque		750 FT/lbs	1016 Nm
Overall Length		9-19/64"	236 mm
Air Inlet		1/4"	
Air Hose (I.D.)		3/8"	9.5 mm
Air Pressure		90 psi	6.2 Bar
Air Consumption		7 cfm	198 l/min
Anvil Length		2"	
Clutch Mechanism		Twin Hammer	
Weight		10.0 lbs	4.55 kg
Exhaust		Side Exhaust	
Sound dBA		87	
Vibration		0.7	



SUPER DUTY AIR IMPACT WRENCH

The new upgraded ultra-light impact wrench consists of carefully designed compact mechanisms that drastically reduced the weight and volume of the tool. With 6 unique functions, the operating efficiency is increased and a comfortable and convenient functionality is achieved.

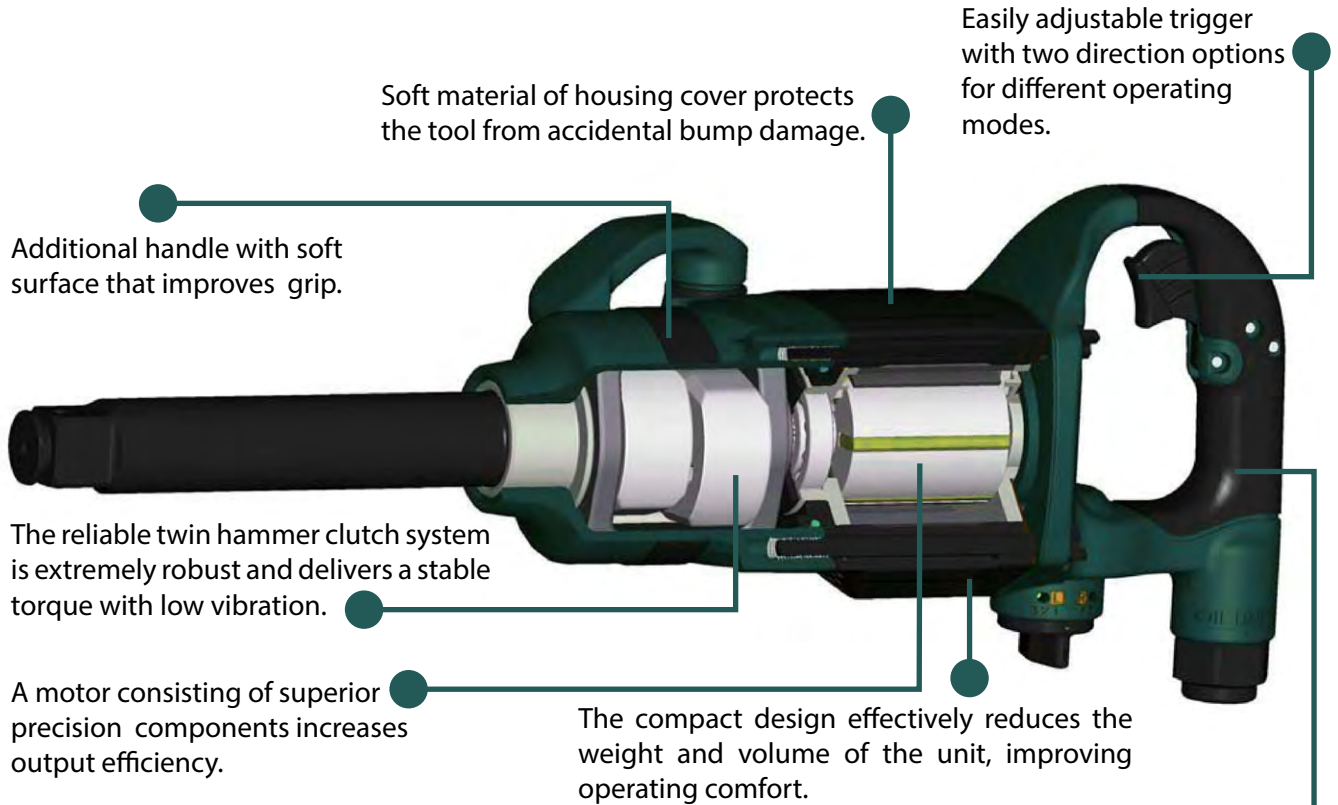

Additional handle with soft surface that improves grip.

Soft material of housing cover protects the tool from accidental bump damage.

Easily adjustable trigger with two direction options for different operating modes.

The reliable twin hammer clutch system is extremely robust and delivers a stable torque with low vibration.

A motor consisting of superior precision components increases output efficiency.

The compact design effectively reduces the weight and volume of the unit, improving operating comfort.



Soft surface design of handle increases operating comfort especially for use over long periods of time.

PNEUMATIC POWER TOOLS

Pneumatics Range

JOP008 JAI-1138L	1" Square Dr. Super Duty Air Impact Wrench W/6" Extended Anvil	
Square Drive	1"	
Standard Bold Size	1-27/64"	M36
Free Speed (rpm)	5,000	
Working Torque	1,800 (ft-lb)	2,430 (Nm)
MAX Torque	2,000 (ft-lb)	2,712 (Nm)
Overall Length	19.2"	487mm
Air Inlet Size	1/2"	
Air Hose (I.D.)	3/4"	
Avg Air Consumption (cfm)	9 (cfm)	255 (l/min)
Net Weight	18.3 (lbs)	8.3 (kg)
Clutch Mechanism	Twin Hammer	
Vibration (M/S ²)	18	
Noise Level (dBA)	98	

Application:

The Super Duty Air Impact Wrench is designed for heavy duty repairs, specialised industrial applications and large scale engineering or construction projects.

Practical uses include mining, truck / heavy vehicle repairs, building and railway applications.



JOP006 JAI-1313		3/8" Dr. Pneumatic Heavy Duty Impact Wrench	
Square Drive	3/8"		
Clutch Mechanism	Twin Hammer		
Exhaust	Rear		
Max Torque	Forward	330 ft-lb / 440 N.M.	
	Reverse	380 ft-lb / 510 N.M.	
Working Torque	Forward	280 ft-lb / 380 N.M.	
	Reverse	320 ft-lb / 430 N.M.	
Free Speed (r.p.m.)	Forward	10 500 rpm	
	Reverse	11 500 rpm	
Std Bolt Capacity	1/2" or 13mm		
Length	159mm		
Weight	1.31kg		
Minimum Hose Size	10mm		
Average Air Consumption:	3.7cfm / 105 l/min		
Vibration	4.96 M\S2 / 0.99 K(M\S2)		
Sound	103.5 dB		



JOP102 & JOP103 JAR-6313	Stubby Air Ratchet Wrench	
	JOP102 JAR-6313	JOP103 JAR-6312
Square Drive	3/8"	1/4"
Std Bolt Capacity	3/8", (M10)	3/8", (M10)
Free Speed (r.p.m.)	230	230
Max. Torque	25 Ft/Lbs 34 Nm	25 Ft/Lbs 34 Nm
Overall Length	6 - 1/2"	6 - 1/2"
	165 mm	165 mm
Air Inlet	1/4"	1/4"
Air Hose (I.D.)	3/8" / 9.5 mm	3/8" / 9.5 mm
Air Pressure	90 psi / 6.2 Bar	90 psi / 6.2 Bar
Air Consumption	3 cfm / 85l/min	3 cfm / 85l/min
Weight	0.5 kg	0.5 kg
Exhaust	Rear	Rear



JOP100 JAR-6309A		1/2" Dr. Heavy Duty Air Ratchet Wrench	
Square Drive	1/2"		
Std Bolt Capacity	3/8"	M10	
Free Speed (r.p.m.)	170		
Max Torque	75 Ft/Lbs	100 Nm	
Overall Length	10-3/4"	275 mm	
Air Inlet	1/4"		
Air Hose (I.D.)	3/8"	9.5 mm	
Air Pressure	90 psi	6.2 Bar	
Air Consumption	4 cfm	113 l/min	
Weight	3.1 lbs	1.4 kg	
Exhaust	Rear		



JOP601 JAT 1024	Finishing Air File
Operating Air Pressure	6.3 kg/cm ²
Stroke per Minute	12000
Stroke Length (mm)	3 - 5
Avg. Air Consumption	6 cfm
Air Inlet Size	1/4" NPTF
Min. Hose Size	3/8" I.D.
Net Weight	0.6 kg
Overall length (mm)	245
Sound Pressure	68 dBA
Vibration	10 m/s ²



JOP502 JAH0288		Air Needle Scaler	
No. of Needles	12 Pc		
Blow per Min. (BPM)	4000		
Overall Length	11 7/16"	290 mm	
Air Inlet	1/4"		
Air Pressure	90 psi		
Air Consumption	230 l/min		
Piston Size	18 x 14 x 47mm		
Weight	1.2 kg		



JOP400 JAG0903RM		6mm Heavy Duty Mini Air Die Grinder	
Free Speed (r.p.m.)	25 000 r.p.m.		
Motor	0.21 Kw	0.3 HP	
Collet Size	¼"	6 mm	
Overall Length	6"	152 mm	
Air Inlet	¼"		
Air Hose (I.D.)	3/8"		
Air Pressure	90 psi	6.2 Bar	
Air Consumption	4 cfm	113 l/min	
Exhaust System	Rear		
Weight	0.77 lbs	0.35 kg	



JOP401 JAG0933R		6mm Heavy Duty Mini Angle Air Die Grinder	
Free Speed (r.p.m.)	18000 r.p.m.		
Motor	0.21 Kw	0.3 HP	
Collet Size	¼"	6 mm	
Overall Length	6.1"	155 mm	
Air Inlet	¼"		
Air Hose (I.D.)	3/8"		
Air Pressure	90 psi	6.2 Bar	
Air Consumption	3 cfm	85 l/min	
Exhaust System	Rear		
Weight	1.08 lbs	0.49 kg	



JOP405 JAG0925RM		¼" Heavy Duty Air Die Grinder	
Free Speed (r.p.m.)	18 000 r.p.m.		
Motor	0.63 Kw	0.9 HP	
Collet Size	¼"	6mm	
Overall Length	7.75"	197mm	
Air Inlet	¼"		
Air Hose (ID)	3/8"		
Air Pressure	90 psi	6.2 Bar	
Air Consumption	6 cfm	170 l/min	
Exhaust System	Rear		
Weight	2.3 lbs	1.05 kg	



JOP406 JAG0973RM		7" Extension 6mm Air Die Grinder	
Free Speed	20000 r.p.m.		
Motor	0.21 Kw	0.3 HP	
Collet Size	¼"	6 mm	
Overall Length	11.13"	282mm	
Air Inlet	¼"		
Air Hose (I.D.)	3/8"		
Air Pressure	90 psi	6.2 Bar	
Air Consumption	4 cfm	113 l/min	
Exhaust System	Rear		
Weight	2 lbs	0.9 kg	



JOP402 JAG6639		7" Professional Angle Grinder (Lever Throttle)	
Free Speed (r.p.m.)	7 000 r.p.m.		
Capacity Bolt Size	7"	180 mm	
Overall Length	13 ½"	343 mm	
Air Inlet (PT)	3/8"		
Air Hose (ID)	½"		
Work Pressure	90 psi	6.2 Bar	
Average Air Consumption	9 cfm	257 l/min	
Net Weight	7.0 lbs	3.1 kg	
Power kg (HP)	1.4 (1.86)		
Spindle Thread	5/8" – 11 UNC		
Sug. Air Comp (HP)	2		



JOP403 JAG6638		5" Professional Air Angle Grinder (Lever Throttle)	
Free Speed (r.p.m.)	11 000 r.p.m.		
Capacity Bolt Size	5"	125 mm	
Overall Length	9"	230 mm	
Air Inlet (PT)	¼"		
Air Hose (ID)	3/8"		
Work Pressure	90 psi	6.2 Bar	
Average Air Consumption	6 cfm	170 l/min	
Net Weight	4.0 lbs	1.8 kg	
Power kg (HP)	0.7 (0.93)		
Spindle Thread	5/8" – 11 UNC		
Sug. Air Comp (HP)	2		
Disc Size	115mm		



JOP302 JAB0310	Air Impact Screwdriver (Twin Hammer)	
Hex Size of Bit (mm)	6.35	
Bolt Size Capacity (mm)	Ø 8-10	
Free Speed (r.p.m.)	6000	
Max Torque	300 Nm	
Air Inlet	¼" NPT	
Air Hose (I.D.)	¼"	
Air Pressure	90psi	
Weight	2.3 kg	



JOP301 JAB0309	Air Impact Screwdriver (Twin Hammer)	
Hex Size of Bit (mm)	6.35	
Bolt Size Capacity (mm)	Ø6-8	
Free Speed (r.p.m.)	6500	
Max Torque	145 Nm	
Air Inlet	¼" NPT	
Air Hose (I.D.)	¼"	
Air Pressure	90 psi	
Weight	1.2 kg	



JOP901 JAT-480	Heavy Duty Manual Operated Grease Gun	
2 Direction outlets designed according to requirements of work sites.		
Standard 14oz. Cartridge		
Pressure Filler		
Bulk 400c.c.		



JOP900 JAT-6004	Air Grease Gun (400CC)	
Capacity Bulk	400 CC	
Capacity Cartridge	14 OZ	
Finish	Gun Head – Oven Painting	
	Container Tube – Chrome Plated	
Size	56.4mm x 400mm	
Pressure Tested	1200 psi TO 6000 psi (WITH 300 psi TO 150 psi COMPRESSED AIR SUPPLY) DEVELOP TO 9000 psi	
Weight	2.08 kg	



JOP606 JAT6421	3" Cut Off Tool	
Technical Data		
Free Speed (r.p.m.)	20000	
Hose Size	3/8"	
Air Pressure	6.2 Bar	
Air Consumption	170 l/min	
Air Inlet	¼"	
Weight	0.76 kg	



JOP503 JAT6613	Air Stripping Tool (Label and Sticker Remover)	
Free Speed (r.p.m.)	3500	
Pad Size (mm)	105	
Air Inlet	1/4"	
Air Pressure	90 psi	
Air Consumption	280 l/min	
Net Weight	0.96 kg	
Length x Height	203 x 106mm	
Exhaust System	Rear	



JOP206 JAD-0413		3/8" Composite Heavy Duty Air Reversible Drill	
Free Speed (rpm)	1,800		
Overall Length	210mm		
Air Consumption (cfm)	3.5 cfm		
Chuck Size	3/8"		
Net Weight	0.95 kg		
Air Inlet Size	1/4"		
Air Hose (I.D.)	3/8"	1/4"	
Exhaust Direction	Rear Exhaust		
Horse Power	0.4 HP		
Vibration (M/S ²)	3.3		
Noise Level (dBA)	80		

JOP207 JAD-0414		1/2" Composite Heavy Duty Air Reversible Drill	
Free Speed (rpm)	800		
Overall Length	245mm		
Air Consumption (cfm)	4 cfm		
Chuck Size	1/2"		
Net Weight	1.4 kg		
Air Inlet Size	1/4"		
Air Hose (I.D.)	3/8"	10mm	
Exhaust Direction	Rear Exhaust		
Horse Power	0.4 HP		
Vibration (M/S ²)	3.2		
Noise Level (dBA)	81		



JOP200 JAD-6233		3/8" Dr. Air Drill	
Free Speed (r.p.m.)	2500		
Capacity of Chuck	3/8"		
Air Inlet	1/4"		
Hose Size (I.D.)	3/8"		
Air Pressure	90 psi	6.2 Bar	
Air Consumption	4 cfm	113 l/min	
Spindle Thread	3/8" - 24 UNF		
Length	6 - 1/2"	165 mm	
Weight	2.5 lbs	1.1 kg	

JOP202 JAD-6243B		1/2" Dr. Air Drill	
Free Speed (r.p.m.)	800		
Capacity of Chuck	1/2"		
Air Inlet	1/4"		
Hose Size (I.D.)	3/8"		
Air Pressure	90 psi	6.2 Bar	
Air Consumption	4 cfm	113 l/min	
Spindle Thread	3/8" - 24 UNF		
Length	7"	178mm	
Weight	4 lbs	1.82 kg	



JOP201 JAD-6234		3/8" Dr. Air Reversible Drill	
Free Speed (r.p.m.)	1800		
Capacity of Chuck	3/8"		
Air Inlet	1/4"		
Hose Size (I.D.)	3/8"		
Air Pressure	90 psi	6.2 Bar	
Air Consumption	4 cfm	113 l/min	
Spindle Thread	3/8" - 24 UNF		
Length	6 - 1/2"	165 mm	
Weight	2.5 lbs	1.1 kg	

JOP203 JAD-6244A		1/2" Dr. Air Reversible Drill	
Free Speed (r.p.m.)	800		
Capacity of Chuck	1/2"		
Air Inlet	1/4"		
Hose Size (I.D.)	3/8"		
Air Pressure	90 psi	6.2 Bar	
Air Consumption	4 cfm	113 l/min	
Spindle Thread	3/8" - 24 UNF		
Length	7"	178mm	
Weight	4 lbs	1.82 kg	



JOP205 JAD-6249		3/8" Air Angle Reversible Drill	
Free Speed	1800		
Capacity of Chuck	3/8"	10 mm	
Air Inlet	1/4"		
Hose Size (I.D.)	3/8"	10 mm	
Air Pressure	90 psi	6.2 Bar	
Air Consumption	4 cfm	113 l/min	
Spindle Thread	3/8" - 24 UNF		
Length	8-1/4"	210 mm	
Weight	2.42 lbs	1.82 kg	



JOP204 JAD-1015K		Air Spot Weld Drill with Hook	
CONTENTS			
1 Pc JAD-1015 Spot Weld Drill			
1 Pc Mini Oiler			
1 Pc Swivel Connector (1/4" x 1/4")			
4 Pc Extra 8mm & 6.5mm Drill Bit			
1 Pc 2.5mm "L" Type Hex Key Wrench			
1 Pc Blow Case			
Technical Data:			
Free Speed	1800		
Air Pressure	90 psi	6.2 Bar	
Air Consumption	10 cfm	283 l/min	
Air Inlet	1/4"		
Drill Capacity (Dia.)	5/16"	8 mm	
Hose Size (I.D.)	3/8"	9.5 mm	
Length	10"	254 mm	
Weight	4.6 lbs	2.1 kg	



JOP1101 JAH0401(K)		Air Hand Nailer Kit	
Adapters: Standard Guide Tip, Magnetic Standard Guide Tip, (S) Short Magnetic Guide Tip, (L) Long Magnetic Guide Tip, Hammer, Rubber Hammer and Chisel			
Additional Tools: Leather Glove, Spanners, Wrench; Spare O-Ring Pack, Oil Pot, Air Plug, Operating Manual and Carrying Case.			
Ideal for nailing wood nogs and drives any length of wood nog.			
Rubber head does not damage nog.			
Ergonomic design for comfort and high power performance.			
Ultra efficient engine desing for ultimate performance.			
Hardened steel nose for extreme durability.			
Balanced weight reduces fatigue.			



JOP405K		Laser Weld Cutter	
1. 1x60mm Heavy Duty Air Die Grinder Motor 0.9 (HP) Free Speed 18 000 (r.p.m.) Capacity Ball Size 6mm Air Inlet 1/4"			
2. 2x Cut off discs, 3" Diameter, 1/8" Thickness, 36 grit size 25 000 r.p.m. max			
3. 1x Mandrel (6mm)			
4. 2x Tungsten carbide burr 6mm Shaft, +/- 5mm Head			



JOP710 - JOP712 JAS-1020-6HE (2.5) - 5		Composite Random Orbital Sander, Self-Generated Vacuum	
	JOP710	JOP712	
Pad Diameter	6"	6"	
Orbit Diameter (mm)	2.5mm	5mm	
Vacuum Mode	Self-Generated Vacuum		
Pad Vace	Hook		
Free Spreed (rpm)	12,000		
Air Consumption (cfm) (l/min)	6cfm (170)		
Weight (kg)	0.96 kg	0.91 kg	

JOP705 JAS-6505		7" Air Sander	
Disc Size	7"	178mm	
Spindle Size	5/8" - 11 UNC		
Free Speed (r.p.m.)	4500		
Overall Length	16"	406mm	
Air Inlet	1/4"		
Air Hose (ID)	3/8"		
Air Consumption	6 cfm	170 l/min	
Air Pressure	90 psi	6.2 Bar	
Suggested Air Compressor	2 HP		
Weight	5.5 lbs	2.5 kg	

JOP709 - JOP711 JAS-1021-6HE (2.5) - 5		Composite Random Orbital Sander, Central Vacuum	
	JOP709	JOP711	
Pad Diameter	6"	6"	
Orbit Diameter (mm)	2.5mm	5mm	
Vacuum Mode	Central Vacuum		
Pad Vace	Hook		
Free Spreed (rpm)	12,000		
Air Consumption (cfm) (l/min)	6cfm (170)		
Weight (kg)	0.96 kg	0.91kg	

JOP800 JAS-6551		7" Air Polisher	
Disc Size	7"	178mm	
Spindle Size	5/8" - 11 UNC		
Free Speed (r.p.m.)	2500		
Overall Length	16"	406mm	
Air Inlet	1/4"		
Air Hose (ID)	3/8"		
Air Consumption	6 cfm	170 l/min	
Air Pressure	90 psi	6.2 Bar	
Suggested Air Compressor	2 HP		
Weight	5.5 lbs	2.5 kg	



JOP706 JAS-6506		7" Air Vertical Sander	
Disc Size	7"	178mm	
Spindle Size	5/8" - 11 UNC		
Free Speed (r.p.m.)	4500		
Overall Length	7-1/2"	190mm	
Air Inlet	1/4"		
Air Hose (ID)	3/8"		
Air Consumption	6 cfm	170 l/min	
Air Pressure	90 psi	6.2 Bar	
Suggested Air Compressor	2 HP		
Weight	6.1 lbs	2.8 kg	

JOP801 JAS-0423		3" Composite Heavy Duty Air Polisher	
Sanding Pad Capacity	3"		
Spindle Thread	5/16" - 24T		
Free Speed (rpm)	2,100		
Air Consumption (cfm)	3.5		
Overall Length	135mm		
Air Inlet Size	1/4"		
Net Weight	0.77 kg		
Air Hose (I.D.)	3/8"	10mm	
Exhaust Direction	Rear Exhaust		
Horse Power	0.4HP		
Vibration (M/S ²)	2.3		
Noise Level (dBA)	78		



JOP603 JAT6034		Air Hydraulic Riveter 3/16" (4.8mm)	
Blind Rivet Setting Capacity	3/32" To 3/16" (2.4 to 4.8mm)		
Traction Power	2299 LBF	1045 kgF	
Stroke Length	0.63"	16 mm	
Air Inlet	1/4"		
Air Hose (I.D.)	3/8"		
Air Pressure	90 psi	6.2 Bar	
Air Consumption	1.48 L/Cycle		
Nose Piece	2.4 (3/32"), 3.2 (1.8"), 4.0 (5/32"), 4.8 (3/16")		
Width x Height	165 x 270 mm		
Weight	3.3 lbs	1.5 kg	

JOP604 JAT6673B		1/4" (6.4mm) Heavy Duty Air Hydraulic Riveter	
Blind Rivet Setting Capacity	3/32" to 1/4" (2.4 to 6.4mm)		
Traction Power	3740 LBF	1700 kgF	
Stroke Length	0.708"	18mm	
Air Inlet	1/4"		
Air Hose	3/8"		
Air Pressure	90 psi	6.2 Bar	
Air Consumption	2.9 L/Cycle		
Nose Piece	2.4 (3/32"), 3.2 (1/8"), 4.0 (5/32"), 4.8 (3/16"), 6.0(7/32"), 6.4(1/4")		
Width x Height	170 X 298mm		
Weight	3.9 lbs	1.75 kg	

MATERIAL		Rivet Diameter (mm)					
Rivet	Mandrel	-2	-2.5	-3	-5		
			2.4	3.2	4	4.8	6.4
Aluminum	Aluminum	✓	✓	✓	✓	✓	
Aluminum	Steel	✓	✓	✓	✓	✓	
Steel	Steel	✓	✓	✓	✓	✓	
Stainless	Steel	✓	✓	✓	✓	✓	
Stainless	Stainless	✓	✓	✓	✓		

MATERIAL		Rivet Diameter (mm)					
Rivet	Mandrel	-2	-2.5	-3	-5		
			2.4	3.2	4	4.8	6.4
Aluminium	Aluminium	✓	✓	✓	✓	✓	✓
Aluminium	Steel	✓	✓	✓	✓	✓	✓
Steel	Steel	✓	✓	✓	✓	✓	✓
Stainless	Steel	✓	✓	✓	✓	✓	✓
Stainless	Stainless	✓	✓	✓	✓	✓	(✓)

AIR PUNCH / FLANGE TOOL



Application:

This tool easily crimp flanges or lap joint sheets and pipes. It also works as both an air punch and air flange for auto body repair jobs.

JOP1200 JAT6943A		Air Punch / Flange Tool	
Cutting Capacity	1.4mm		
Punch	8.0mm		
Flange Width	12mm		
Air Inlet	1/4"		
Air Pressure	6.2 bar		
Overall Length	248mm		
Weight	1.3 kg		





PNEUMATIC POWER TOOLS

JOP501 JAH302HK	Shock Reduction Air Hammer Kit (Hex)
1 Pc Spring Retainer 1 Pc Quick Change Retainer 4 Pc 7" CR-MO Chisel JAH3901 Panel Cutter JAH3904 Spot Weld Cutter JAH 3934 Tapered Punch JAH3935 Single End Cutter	
Chisel Shank Opening	0.401"
Bore Diameter	19 mm
Stroke Length	2-5/8"
Blows Per Minute	3,500
Working Air Pressure	90 psi
Average Air Consumption	4 cfm
Net Weight	1.7 kg
Air Inlet Size	1/4" NPT (PT)
Air Hose Size	3/8"

JOP600 JAT1020K	Low Vibration Mechanism Air Saw Kit
CONTENTS	1 Pc JAT1010 Low Vibration Air Saw
	5 Pc Saw Blades 18 t.p. inch
	5 Pc Saw Blades 24 t.p. inch
	5 Pc Saw Blades 32 t.p. inch
Cutting Capacity - Thickness (gauge)	Steel 2.91mm Aluminium 3.26mm
Operating Air Pressure (Max)	6.3 kg/cm ²
Strokes per Minute @ 90psi	10 000
Avg. Air Consumption	6 cfm
Net Weight	0.76 kg
Air Inlet	1/4" NPT (PT)
Air Hose Size	I.D. 3/8"
Overall Length	226mm
Vibration	< 9 m/s ²
Sound Pressure	< 85 dBA

Pneumatics Range



PNEUMATIC CONSUMABLES



JOP452
JAZ0055AH PU Velcro Sanding Pads
Hard Surface

JOP453
JAZ0055BH PU Velcro Sanding Pads
Soft Surface

7 Hole design with 14mm extraction holes. Ensures perfect alignment and reduced risk of "pigtailed".

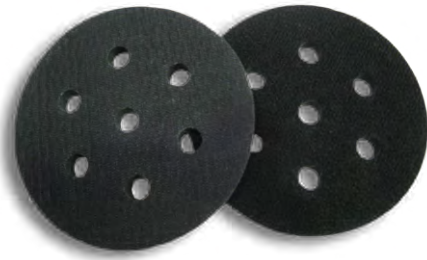

JOP454
JAZ0060 Interface Pads

7 Hole design with 14mm extraction holes. Ensures perfect alignment and reduced risk of "pigtailed".
2 Pads per pack.



JOP502ap
JAH0288-15 Chisel for Air Needle Scaler
JOP502



JOP502aq
JAH0288-16 12 Pc Needle Set for Air Needle Scaler
JOP502



JOP2000
JAZ0042 1/4" Universal Swivel Air Inlet
Joint

JOP2001
JAZ0043 3/8" Universal Swivel Air Inlet
Joint

JOP2002
JAZ0044 1/2" Universal Swivel Air Inlet
Joint

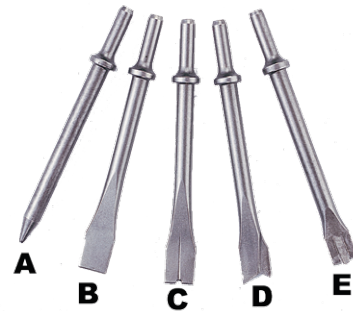

JOP550
JAZ3945H 5 Pc Long Chisel (Hex) Shank
0.39", l 125mm

JOP551
JAZ3934H Tapered Punch for Air Hammer, l 170mm (A)

JOP552
JAZ3903H Flat Chisel for Air Hammer, l 170mm (B)

JOP553
JAZ3904H Spot Weld cutter for Air Hammer, l 170mm (C)

JOP554
JAZ3935H Single End Cutter for Air Hammer, l 170mm (D)

JOP555
JAZ3901H Panel Cutter for Air Hammer, l 170mm (E)



JOP2100
JA3806C In Line Regulator



JOP250
JA7206 5 Pc 8.0mm diam. Spot Drill Bit Set
HSS

JOP252
JA7206T 5 Pc 8.0mm diam. Spot Drill Bit Set
Titanium HSS



JOP653
JAT6442KA 115mm Blades for Air
Windshield Knife

JOP654
JAT6442KB 153mm Blades for Air
Windshield Knife

JOP655
JAT3442KC 203mm Blades for Air
Windshield Knife



JOP801BE
JAS0423-31 3" Velcro Pad for JOP801

Pneumatics Range



JOP650 JAT10T18	5 Pc Saw Blade 18 Teeth for Air Saw, l 75mm
JOP651 JAT10T24	5 Pc Saw Blade 24 Teeth for Air Saw, l 75mm
JOP652 JAT10T32	5 Pc Saw Blade 32 Teeth for Air Saw, l 75mm



JOP656 JAT12F1	Triangular File for Finishing Air File. Shank 5mm.
JOP657 JAT12F2	Half Round File for Finishing Air File. Shank 5mm.
JOP658 JAT12F3	Round File for Finishing Air File. Shank 5mm.
JOP659 JAT12F4	Rectangular File for Finishing Air File. Shank 5mm.

JOP50349 JAT6613-P	Eraser Pad
Consumable for Air Stripper Tool (JOP503)	
Eraser Pad size	105mm



JONNESWAY
PROFESSIONAL TOOL RANGE
Racing





HAND TOOLS





WRENCH SETS



JOT315 W26126S	26 Pc Combination Wrench Set (mm)
Contents:	6, 7, 8, 9, 10, 11, 12, 13, 14, 15, 16, 17, 18, 19, 20, 21, 22, 23, 24, 25, 26, 27, 28, 29, 30, 32mm



JOT320 W69112S	12 Pc 75 Degree Offset Combination Wrench Set (mm)
Contents:	8, 9, 10, 11, 12, 13, 14, 15, 16, 17, 19, 22mm



JOT340 W26114SA	14 Pc Combination Wrench Set (mm)
Contents:	10, 11, 12, 13, 14, 16, 17, 19, 21, 22, 24, 27, 30, 32mm



JOT349 W26414S	14 Pc Combination Wrench Set (SAE)
Contents:	3/8", 7/16", 1/2", 9/16", 5/8", 11/16", 3/4", 13/16", 7/8", 15/16", 1", 1 1/16", 1 1/8", 1 1/4"



JOT342 W23108S	8 Pc 75° Offset Ring Wrench Set (mm)
Contents:	6x7, 8x9, 10x11, 12x13, 14x15, 16x17, 18x19, 20x22mm
Wrenches individually available. (JOT6770607 - JOT6772022)	



JOT314 W24106SL	6 Pc Flare Nut Wrench Set (mm)
Contents:	8x10, 11x13, 12x14, 13x14, 17x19, 24x27mm



JOT316 W53208S	8 Pc Midget Combination Wrench Set (SAE)
Contents:	5/16", 3/8", 7/16", 1/2", 9/16", 5/8", 11/16", 3/4"



JOT341 W53108S	8 Pc Midget Combination Wrench Set (mm)
Contents:	8, 9, 10, 12, 13, 14, 17, 19mm

Hand Tool Range



JOT30106 W45106S	6 Pc 72 Teeth Ratcheting Combination Wrench Set (mm)
Contents:	10, 11, 13, 14, 17, 19mm



JOT301 W45108S	8 Pc 72 Teeth Ratcheting Combination Wrench Set (mm)
Contents:	10, 11, 12, 13, 14, 15, 17, 19mm



JOT689 W66107S	7 Pc Flexible Ratcheting Combination Wrench Set 72 Teeth (mm)
Contents:	8, 10, 11, 13, 14, 17, 19mm



JOT302 W60107S	7 Pc 72 Teeth Reversible Ratcheting Combi Wrench (mm)
Contents:	10, 11, 13, 14, 16, 17, 19mm



JOT20810 W51110S	10 Pc 72 Teeth Stubby Type Ratcheting Combination Wrench Set (mm)
Contents:	8, 10, 11, 12, 13, 14, 15, 16, 17, 19mm



JOT209 W66207S	7 Pc Flexible Ratchet Wrench Set (SAE)
Contents:	3/8", 7/16", 1/2", 9/16", 5/8", 11/16", 3/4"



JOT687 W45316S	16 Pc 72 Teeth Ratchet Combination Spanner Set (mm)
Contents:	12 Pc Ratcheting Wrench: 8,9,10,11,12,13,14,15, 16,17,18,19mm
	3 Pc Socket Adapter with Quick Release: 1/4", 3/8", 1/2" Dr.
	1 Pc Bit Holder
	Wrenches individually available. (JOT68708 - JOT68719)

WRENCH SETS

Hand Tool Range



WRENCH SETS



JOT207 W45408S	8 Pc 72 Teeth Ratcheting Combination Wrench Set (SAE)
Contents:	5/16", 3/8", 7/16", 1/2", 9/16", 5/8", 11/16", 3/4"



JOT681 W26116SC	16 Pc Combination Wrench Set
Contents:	6,7,8,9,10,11,12,13,14,15,16,17,18,19,22,24mm



JOT684 W32206SC	6 Pc 45° Offset Ring Wrench Set
W322	1/4"x5/16", 3/8"x7/16", 1/2"x9/16", 5/8"x11/16", 3/4"x13/16", 7/8"x15/16"

JOT674 W03112SC	12 Pc Non-slip Close End and Fast Operating Wrench Set
W03	10,11,12,13,14,15,16,17,18,19,21,22mm

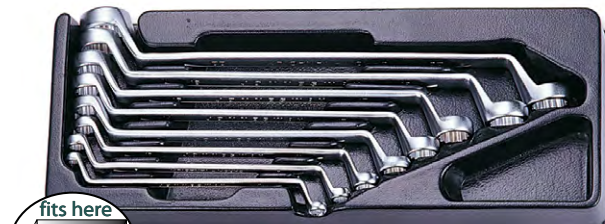

JOT682 W26308SC	8 Pc Mechanic Tools Set
W26	6 Pc Combination Wrench German Type: 8,10,12,13,14,17mm
AN01009A	1 Pc Plug key in mm
W27AS12	1 Pc 12" Adjustable Wrench

JOT677 W23108SC	8 Pc 75° Offset Ring Wrench Set
W23	6x7,8x9,10x11,12x13,14x15,16x17,18x19,20x22mm



JOT683 W264210SC	10 Pc Combination Wrench with Measuring Tape Set
W264	9 Pc 12 Pt Combination Wrench Set, CR-V, Mirror Polished SAE Size: 3/8", 7/16", 1/2", 9/16", 5/8", 11/16", 3/4", 13/16", 7/8"
MT4003	1 Pc 25ft Measuring Tape, ABS Case with TPR Coat

JOT679 W2554211SC	10 Pc Wrench Set & Ratchet Handle
W472	4 Pc Ratcheting, Box Wrench Set SAE Size: 1/4"x5/16", 1/2"x9/16", 3/8"x7/16", 5/8"x11/16"
W254	6 Pc Double Open End Wrench, CR-V, Mirror Polish (W25406ST) SAE Size: 1-4"x5/16", 3/8"x7/16", 1/2" x 9/16", 5/8"x11/16", 3/4"x7/8", 15/16"x1"
R3803	1 Pc 3/8" Dr. 48 Teeth Stubby Type Ratchet Handle

Hand Tool Range

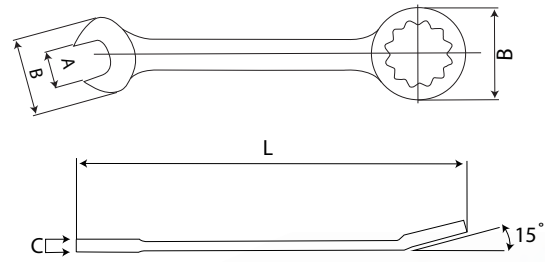

JOT31406 – JOT31450 W26106 – W26150			Combination Wrench (mm)			
Item	Art. No	Size (mm)	BxB1 (mm)	CxC1 (mm)	l (mm)	(g)
JOT31406	W26106	6	15.5 x 10.1	4.2x4.7	105	15
JOT31407	W26107	7	17.0x11.5	4.4x5.0	115	18.8
JOT31408	W26108	8	19.2x12.8	4.6x5.5	125	23.5
JOT31409	W26109	9	21.2x14.2	4.8x5.9	135	32.1
JOT31410	W26110	10	23.2x15.6	5.0x6.5	145	40
JOT31411	W26111	11	25.3x16.9	5.4x6.9	155	50
JOT31412	W26112	12	27.2x18.3	5.5x7.3	165	61
JOT31413	W26113	13	29.4x19.7	5.9x7.8	175	74
JOT31414	W26114	14	31.5x21.2	6.2x8.3	185	83
JOT31415	W26115	15	33.2x22.5	6.4x8.6	195	100
JOT31416	W26116	16	34.7x24.0	6.7x8.9	205	111
JOT31417	W26117	17	36.5x25.3	6.9x9.3	215	125.6
JOT31418	W26118	18	38.7x26.8	7.2x9.9	225	146
JOT31419	W26119	19	40.7x28.1	7.4x10.5	235	156
JOT31420	W26120	20	43.1x29.7	7.7x10.9	245	186
JOT31421	W26121	21	44.8x31.3	8.0x11.3	255	207
JOT31422	W26122	22	46.9x32.6	8.2x11.5	265	226
JOT31423	W26123	23	48.3x34.2	8.4x11.8	275	261
JOT31424	W26124	24	50.4x35.5	8.7x12.1	285	276
JOT31425	W26125	25	52.0x36.9	8.9x12.5	295	319
JOT31426	W26126	26	53.6x38.2	9.2x12.8	305	357
JOT31427	W26127	27	55.7x39.6	9.4x13.1	315	365
JOT31428	W26128	28	57.6x40.9	9.7x13.3	325	402
JOT31429	W26129	29	59.7x42.3	9.9x13.5	335	442
JOT31430	W26130	30	61.8x43.7	10.1x13.7	345	502
JOT31432	W26132	32	65.8x46.4	10.4x14.3	365	572
JOT31434	W26134	34	69.2x48.4	10.7x15.0	380	649
JOT31436	W26136	36	74.0x53.0	13.5x19.4	410	812
JOT31438	W26138	38	77.0x56.0	15.0x20.4	430	989
JOT31441	W26141	41	84.0x61.0	16.0x21.6	460	1160
JOT31446	W26146	46	92.0x66.0	17.0x23.0	500	1800
JOT31450	W26150	50	102.0x73.0	18.0x24.6	540	2204

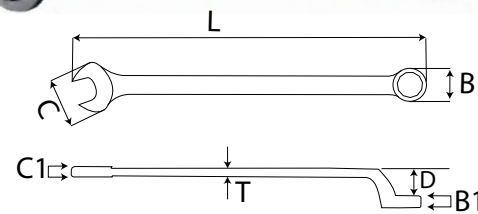

JOT32006 – JOT32024 W69106 – W69124		75° Combination Wrench (mm)				
Code	ItemNo	Size (mm)	l (mm)	C (mm)	B (mm)	D (mm)
JOT32006	W69106	6	130	17	12.2	2.2
JOT32007	W69107	7	130	17	12.2	2.2
JOT32008	W69108	8	140	19.2	14.2	2.3
JOT32009	W69109	9	150	21.2	15.2	2.3
JOT32010	W69110	10	160	23.2	17.2	2.4
JOT32011	W69111	11	170	25.3	18.5	2.5
JOT32012	W69112	12	180	27.2	20	2.7
JOT32013	W69113	13	190	29.4	21.5	2.8
JOT32014	W69114	14	200	31.5	23.1	2.9
JOT32015	W69115	15	210	33.2	24.5	2.9
JOT32016	W69116	16	220	34.7	26	3
JOT32017	W69117	17	230	36.5	27.5	3.1
JOT32018	W69118	18	240	38.7	29	3.2
JOT32019	W69119	19	250	40.7	30.5	3.3
JOT32021	W69121	21	270	44.5	34.1	3.5
JOT32022	W69122	22	280	46.6	35.1	3.6
JOT32024	W69124	24	300	50	38	3.6

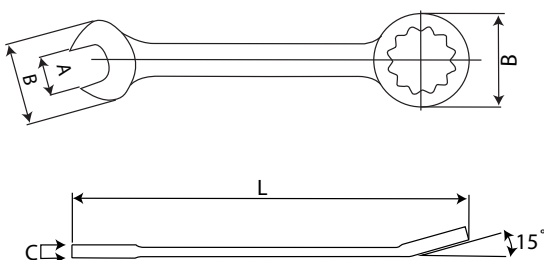

JOT30310 – JOT30319 W26410PR–W26419PR			Combination Wrench Long Pattern Type (mm)			
Item	Art. No	Size (mm)	BxB1 (mm)	CxC1 (mm)	L (mm)	(g)
JOT30310	W26410PR	10	20.8x15.4	5.1x7.4	161	55
JOT30311	W26411PR	11	23.2x17.2	5.9x7.8	168	61.5
JOT30312	W26412PR	12	24.0x17.8	5.9x8.2	174	77.6
JOT30313	W26413PR	13	26.5x19.2	6.3x8.6	180	83.7
JOT30314	W26414PR	14	26.8x10.0	6.3x8.6	193	107.3
JOT30315	W26415PR	15	30.8x22.5	7.1x9.0	200	122.1
JOT30317	W26417PR	17	34.4x24.4	7.9x10.4	227	171.5
JOT30319	W26419PR	19	39.1x27.7	9.3x11.5	250	207.0

WRENCHES - INDIVIDUALLY AVAILABLE

Hand Tool Range



JOT30210 – JOT30219 W60110 – W60119			72 Teeth Reversible Ratcheting Combi Wrench (mm)					
ItemCode	Part Number	Size (mm)	l (mm)	A (mm)	B (mm)	C (mm)	D (mm)	W (mm)
JOT30210	W60110	10	158	8.4	21.5	4.8	22	9.3
JOT30211	W60111	11	184	8.4	23	5.1	23.8	10.3
JOT30212	W60112	12	170	8.7	24.8	5.3	26	11.2
JOT30213	W60113	13	177	9.1	25.1	5.8	27.5	12
JOT30214	W60114	14	190	9.5	27.8	6	30.5	12.9
JOT30216	W60116	16	207	10.5	30.9	6.5	34	15
JOT30217	W60117	17	224	11	32.3	7.3	36	15.8
JOT30219	W60119	19	246	12	35.5	8.3	40.2	17.1

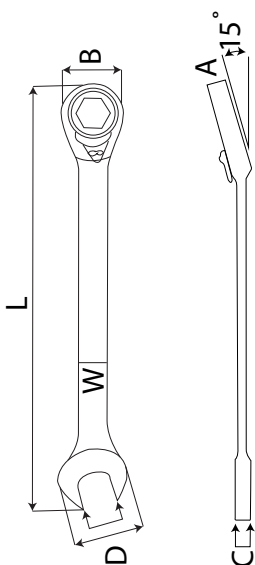

JOT68708 - JOT68719 W45108 - W45119			72 Teeth Ratcheting Combination Wrench (mm)					
Item	Art. No	Size (mm)	A (mm)	B (mm)	C (mm)	D (mm)	E (mm)	(g)
JOT68708	W45108	8mm	135.4	17.1	4.9	6.9	16.55	38
JOT68709	W45109	9mm	159.5	20.7	5.8	7.5	20.2	60
JOT68710	W45110	10mm	159.5	20.7	5.8	7.5	20.2	60
JOT68711	W45111	11mm	165.9	22.6	6	8.3	22.4	68
JOT68712	W45112	12mm	168.6	23.8	6.2	8.3	24.9	84
JOT68713	W45113	13mm	178.5	24.9	6.5	8.5	26.4	94
JOT68714	W45114	14mm	190.5	27	7	8.6	28.24	104
JOT68715	W45115	15mm	199.4	28.1	7.2	9.6	31	130
JOT68716	W45116	16mm	206.4	29.9	7.8	9.6	33.27	148
JOT68717	W45117	17mm	225.4	31.9	8.2	19.8	35.53	192
JOT68718	W45118	18mm	236.4	33.4	8.6	10.6	36.4	192
JOT68719	W45119	19mm	247.4	34.4	8.8	10.6	38.4	240

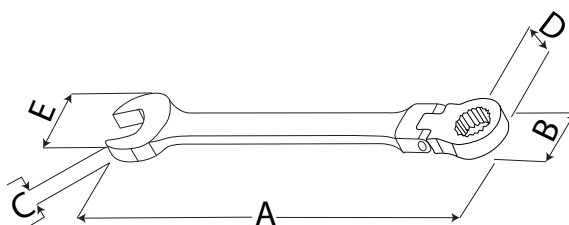
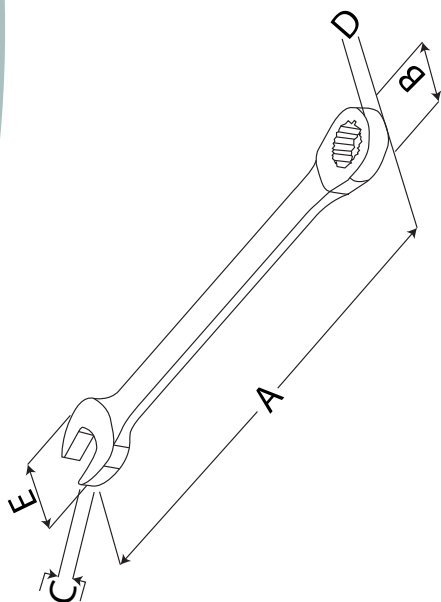

JOT68908 - JOT68919 W66108 - W66119			72 Teeth Flexible Ratcheting Combination Wrench (mm)				
Item	Art. No	Size (metric)	A (mm)	B (mm)	C (mm)	D (mm)	E (mm)
JOT68908	W66108	8mm	137	17.4	4.9	7.4	16.95
JOT68910	W66110	10mm	159	20.9	5.8	7.4	20.8
JOT68911	W66111	11mm	175	23.4	6.2	8.7	25.1
JOT68913	W66113	13mm	186	24.9	6.4	8.7	27.15
JOT68914	W66114	14mm	194	27.4	7.0	8.7	29.3
JOT68917	W66117	17mm	232	31.9	8.2	10.3	35.2
JOT68919	W66119	19mm	250	33.9	9.2	10.3	39.4



WRENCHES - INDIVIDUALLY AVAILABLE

Hand Tool Range



WRENCHES - INDIVIDUALLY AVAILABLE

Hand Tool Range

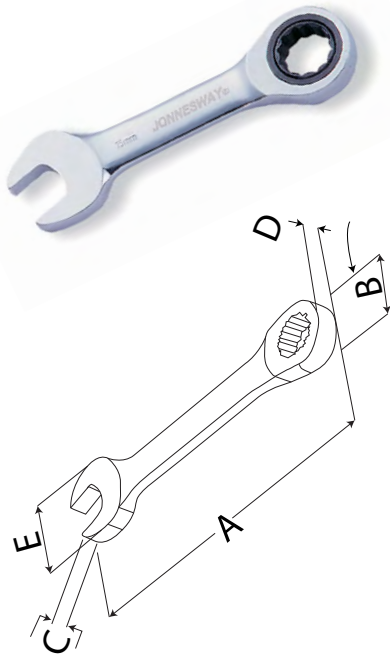

**JOT2081116 - JOT208916
W51217 - 51214** 72 Teeth Stubby Type Ratcheting Combination Wrench (mm)

Item	Art. No	Size (mm)	A (mm)	B (mm)	C (mm)	D (mm)	E (mm)	Weight (g)
JOT20810a	W51108	8	93	17.4	4.9	7.4	16.53	30
JOT20810b	W51110	10	95.4	20.9	5.8	7.4	20.19	40
JOT20810c	W51111	11	105	23.4	6.2	8.7	25.1	60
JOT20810d	W51112	12	105	23.4	6.2	8.7	25.1	60
JOT20810e	W51113	13	106.4	24.9	6.4	8.7	26.64	65
JOT20810f	W51114	14	115	27.4	7	8.7	28.3	85
JOT20810g	W51115	15	112	30.4	7.8	10.3	33.3	110
JOT20810h	W51116	16	122	30.4	7.8	10.3	33.3	110
JOT20810i	W51117	17	125.4	31.9	8.2	10.3	35.5	130
JOT20810j	W51119	19	138	33.9	9.2	10.3	39.6	165

**JOT2081116 - JOT208916
W51217 - 51214** 72 Teeth Stubby Type Ratcheting Combination Wrench (SAE)

Item	Art. No	Size (Inch)	A (mm)	B (mm)	C (mm)	D (mm)	E (mm)	Weight (g)
JOT2081116	W51217	11/16"	125.4	31.9	8.2	10.3	35.5	130
JOT20812	W51213	1/2"	106.4	24.9	6.4	8.7	26.64	65
JOT20838	W51210	3/8"	95.4	20.9	5.8	7.4	20.19	40
JOT20858	W51216	5/8"	122	30.4	7.8	10.3	33.3	110
JOT208716	W51211	7/16"	105	23.4	6.2	8.7	25.1	60
JOT208916	W51214	9/16"	115	27.4	7	8.7	28.3	85

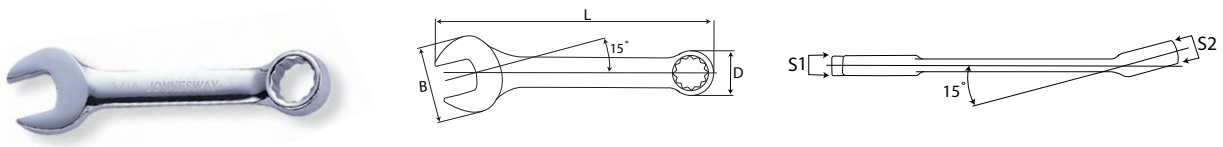

**JOT34108 – JOT34119
W53108 – W53119** Midget Spanner (mm)

Item	ItemNo	Size mm)	l (mm)	B (mm)	D (mm)	S1 (mm)	S2 (mm)	Weight (g)
JOT34108	W53108	8	86	17.2	12.8	4	5.4	19.8
JOT34109	W53109	9	95	22.6	15.2	4.6	6.6	29.8
JOT34110	W53110	10	95	22.6	15.2	4.6	6.6	29.4
JOT34111	W53111	11	99	24.6	16.8	5	7.4	37.9
JOT34112	W53112	12	99	24.6	16.8	5	7.4	37.9
JOT34113	W53113	13	107	28.7	19.8	5.8	8.1	59.5
JOT34114	W53114	14	113	31.3	20.8	6	8.9	71
JOT34115	W53115	15	113	31.3	20.8	6	8.9	83.3
JOT34116	W53116	16	121	35	23.8	6.6	10.1	84.5
JOT34117	W53117	17	127	37.5	25	6.8	10.8	107.1
JOT34118	W53118	18	127	37.5	25	6.8	10.8	116.7
JOT34119	W53119	19	137	41.3	28	7.8	11.9	142.5

**JOT316516 – JOT31634
W53208 – W53219** Midget Spanner (SAE)

Item	ItemNo	Size (inch)	l (mm)	B (mm)	D (mm)	S1 (mm)	S2 (mm)	Weight (g)
JOT316516	W53208	5/16"	86	17.2	12.8	4	5.4	19.8
JOT31638	W53210	3/8"	95	22.6	15.2	4.6	6.6	29.4
JOT316716	W53211	7/16"	99	24.6	16.8	5	7.4	37.9
JOT31612	W53213	1/2"	107	28.7	19.8	5.8	8.1	59.5
JOT316916	W53214	9/16"	113	31.3	20.8	6	8.9	71
JOT31658	W53216	5/8"	121	35	23.8	6.6	10.1	84.5
JOT3161116	W53217	11/16"	127	37.5	25	6.8	10.8	107.1
JOT31634	W53219	3/4"	137	41.3	28	7.8	11.9	142.5

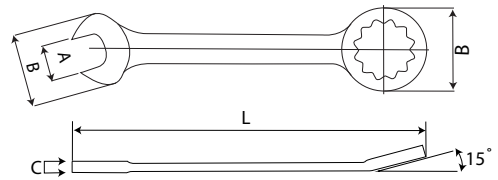

WRENCHES - INDIVIDUALLY AVAILABLE

Hand Tool Range

JOT31906 – JOT31963 W26406 – W26463			Combination Wrench (SAE)			
Code	Item No	Size (Inch)	BxB1 (mm)	CxC1 (mm)	l (mm)	Weight (g)
JOT31906	W26406	1/4"	15.3x10.6	4.3x5.8	129	0.216
JOT31908	W26408	5/16"	18.5x13.0	4.7x6.6	142	0.302
JOT34910	W26410	3/8"	20.8x15.4	5.1x7.4	161	55
JOT34911	W26411	7/16"	23.2x17.2	5.9x7.8	168	61.5
JOT34913	W26413	1/2"	26.5x19.2	6.3x8.6	180	83.7
JOT34914	W26414	9/16"	26.8x10.0	6.3x8.6	193	107.3
JOT34916	W26416	5/8"	32.7 x 23.0	7.9 x 9.2	207	134.4
JOT34917	W26417	11/16"	34.4x24.4	7.9x10.4	227	171.5
JOT34919	W26419	3/4"	39.1x27.7	9.3x11.5	250	279
JOT34921	W26421	13/16"	43.5x30.8	9.8x12.7	271	336
JOT34922	W26422	7/8"	45.8x32.7	10.2x13.5	295	369
JOT34924	W26424	15/16"	49.5x34.6	10.5x14.2	317	407.8
JOT34925	W26425	1"	51.5x36.6	11.4x14.9	339	495.3
JOT34927	W26427	1-1/16"	55.3x38.6	12.1x15.7	362	600
JOT34930	W26430	1-1/8"	58.5x42.4	12.8x16.5	394	818
JOT34932	W26432	1-1/4"	65.0x45.6	13.4x18.0	429	997
JOT31933	W26433	1-5/16"	71.0x49.5	15.5x19.0	471	1.13
JOT31934	W26434	1-3/8"	71.0x49.5	15.5x19.0	471	1.15
JOT31935	W26435	1-7/16"	76.0x55.0	16.5x19.0	510	1.23
JOT31936	W26436	1-1/2"	76.0x55.0	16.5x19.0	510	1.27
JOT31937	W26437	1-5/8"	83.0x66.0	17.4x19.0	550	1.67
JOT31938	W26438	1-11/16"	83.0x66.0	17.4x19.0	550	1.67
JOT31942	W26441	1-3/4"	86.0x61.0	19.0x20.5	613	2.2
JOT31946	W26446	1-7/8"	96.0x73.0	19.0x24.0	651	2.618
JOT31948	W26448	1-15/16"	96.0x73.0	19.0x24.0	651	2.816
JOT31950	W26450	2"	96.0x73.0	19.0x24.0	651	3
JOT31953	W26453	2-1/8"	113.0x82.0	23.4x31.0	724	4.58
JOT31955	W26455	2-3/16"	113.0x82.0	23.4x31.0	724	4.58
JOT31957	W26457	2-1/4"	113.0x82.0	23.4x31.0	724	4.58
JOT31960	W26460	2-3/8"	119.0x93.5	119.0x93.5	743	5.6

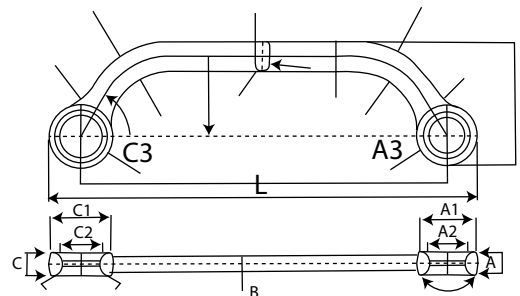

JOT304 – JOT307 W6510810 – W6511517			Double Ended Ring Spanner (mm)									
Item	Art.	Size (mm)	l (mm)	A (mm)	A1 (mm)	A2 (mm)	A3 (mm)	C (mm)	C1 (mm)	C2 (mm)	C3 (mm)	B (mm)
JOT304	W6510810	8X10	125	7	12.5	6	14	7.4	16.5	6.6	16.5	5
JOT305	W6511012	10X12	149	8	17.5	9.2	19.5	8.5	19	10	21	5.5
JOT306	W6511315	13X15	169	9.5	20	11	22	10	22.5	12	24	6.5
JOT307	W6511517	15X17	194	9.5	23.5	14.2	26.5	10	27	15.5	29	7



WRENCHES - INDIVIDUALLY AVAILABLE

Hand Tool Range

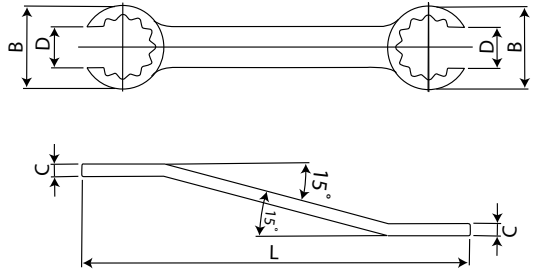

JOT308 – JOT313 W240810 – W241719		Flare Nut Wrench (mm)					
Item	Art. No	Size	BxB1	C	DxD1	L	(g)
		(mm)	(mm)	(mm)	(mm)	(mm)	
JOT308	W240810	8 x 10	18.0 x 20.0	7.0 x 8.5	6.0 x 7.0	145	50
JOT309	W241011	10 x 11	20.0 x 22.0	8.5 x 9.0	7.0 x 8.5	152	65
JOT310	W241012	10 x 12	20.0 x 22.0	8.5 x 9.0	7.0 x 9.0	152	65
JOT311	W241113	11 x 13	22.0 x 26.0	9.0 x 10.5	8.5 x 10.0	165	110
JOT312	W241213	12 x 13	22.0 x 26.0	9.0 x 10.5	8.5 x 10.0	165	110
JOT313	W241719	17 x 19	30.0 x 32.0	12.0 x 14.0	14.0 x 15.0	210	180
JOT321	W241214	12 x 14	24.0 x 28.0	9.5 x 11.0	9.0 x 11.0	178	150
JOT322	W241314	13 x 14	24.0 x 28.0	9.5 x 11.0	9.0 x 11.0	178	150
JOT323	W242427	24 x 27	42.0 x 46.0	17.0 x 18.0	18.0 x 20.0	265	350

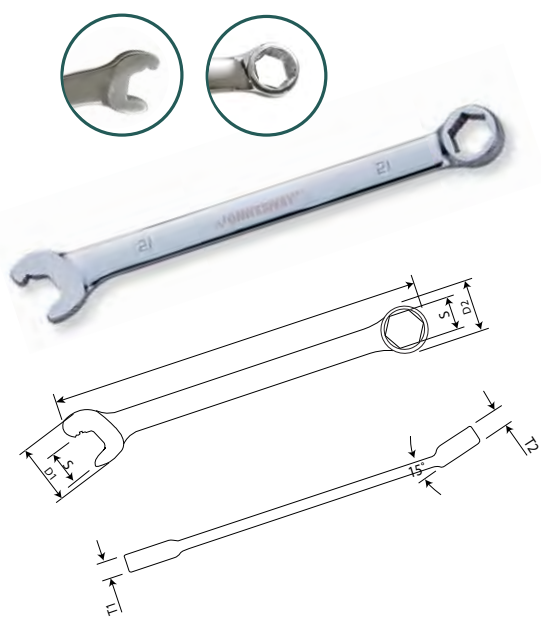

JOT67410 - JOT67422 W03110 - W03122		Non-slip Close End and Fast Operating Wrench (mm)						
Item	Art. No	Size (metric)	D1 (mm)	D2 (mm)	T1 (mm)	T2 (mm)	L (mm)	(g)
JOT67410	W03110	10mm	18.3	16.0	5.0	7.5	163	50
JOT67411	W03111	11mm	20.4	18.0	5.8	8.5	168	60
JOT67412	W03112	12mm	22.0	19.0	5.8	8.5	175	66
JOT67413	W03113	13mm	23.8	21.0	6.8	9.5	181	73
JOT67414	W03114	14mm	26.2	22.0	6.8	9.5	195	93
JOT67415	W03115	15mm	27.5	23.0	7.0	10.5	201	99
JOT67416	W03116	16mm	29.3	25.0	8.0	10.5	209	128
JOT67417	W03117	17mm	31.1	26.0	8.0	11.5	229	142
JOT67418	W03118	18mm	33.0	28.0	8.5	12.5	241	177
JOT67419	W03119	19mm	34.9	29.0	8.5	12.5	252	180
JOT67421	W03121	21mm	40.3	32.0	9.5	13.5	273	300
JOT67422	W03122	22mm	42.2	34.0	10.0	14.5	284	310



JOT343 – JOT348 W290608 – W292024		E – Torx Wrench		
Item	Art. No	Size	l (mm)	Weight (g)
JOT343	W290608	E6XE8	112	14
JOT344	W290711	E7XE11	125	30
JOT345	W291012	E10XE12	140	30
JOT346	W291418	E12XE18	180	70
JOT347	W291622	E16XE22	200	124
JOT348	W292024	E20XE24	224	144

JOT2151719 – JOT2153032 R23B1719 – R23B3032		Double Socket Ratchet Wrench (Construction Wrench)			
Item	Art. No	Size	l (mm)	Capacity (kg/m)	Wt (g)
JOT2151719	R23B1719	17X19	315	52-60	450
JOT2151924	R23B1924	19X24	360	73-80	800
JOT2152427	R23B2427	24x27	360	73-80	800
JOT2152430	R23B2430	24x30	360	160-170	1400
JOT2152730	R23B2730	27x30	450	160-170	1400
JOT2153032	R23B3032	30x32	450	160-170	1400



VARIOUS & ADJUSTABLE WRENCHES



JOT35110 W27AS10		10" Adjustable Angle Wrench					
Size		Max Jaw Opening not less than	Using Range for		Load bending test (cm-kgF)	Overall length (inch)	Weight (g)
Inch	mm		Metric	SAE			
10"	250	29mm	M1 - M18	W1/8 - W5/8	5204	10" (250mm)	410 - 425g

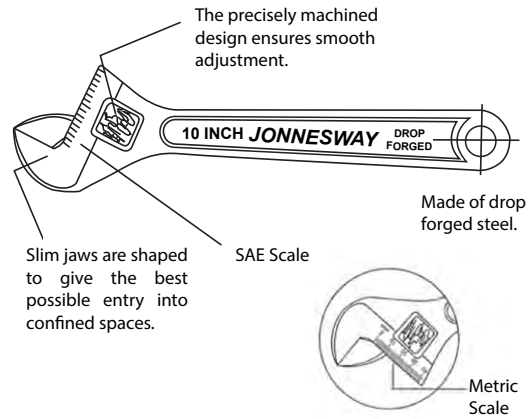

JOT3508 – JOT3515 W27AT8 – W27AT15			Tiger's Paw Adjustable Wrench		
Code	ItemNo	Size (inch/mm)	Standard Jaw Opening Width (mm)	Maximum Jaw Opening Not Less Than (mm)	Weight (g)
JOT3508	W27AT8	8" (200mm)	24	28.6	242
JOT3510	W27AT10	10" (250mm)	29	32.8	397
JOT3512	W27AT12	12" (300mm)	34	38.1	609
JOT3515	W27AT15	15" (375mm)	43	51.0	1140



JOT35210 – JOT35218 W2810 – W2814		Pipe Wrench				Weight (g)
Code	ItemNo	Size		Jaw Capacity (Pipe Size I.D.)		
		Inch	mm	Inch	mm	
JOT35210	W2810	10"	250	1-1/2"	38.1	650
JOT35212	W2812	12"	300	2"	50.8	950
JOT35214	W2814	14"	350	2"	50.8	1250
JOT35218	W2818	18"	450	2-1/2"	63.5	2000

JOT460 W43A106S	Double Flexible Socket Wrench Set 6 Pc (mm)
Contents: 8x9; 10x11; 12x13; 14x15; 16x17; 18x19	



JOT317 R19H38SD	8 Pc 3/8" Dr. Crowfoot Wrench Set (SAE)
Contents: 3/8", 7/16", 1/2", 9/16", 5/8", 11/16", 3/4", 7/8"	



JOT318 R19H310S	10 Pc 3/8" Dr. Crowfoot Wrench Set (mm)
Contents: 10,11,12,13,14,15,16,17,18,19mm	
JOT31812 - 3/8" Dr. Crowfoot Wrench 12mm	
JOT31814 - 3/8" Dr. Crowfoot Wrench 14mm	

JOT4600809 - JOT4601819 W43A0809 - W43A1819		Double Flexible Socket Wrench (mm)		
Item	Art. No	Size (mm)	l (mm)	Weight (g)
JOT4600809	W43A0809	8 x 9	180	78
JOT4601011	W43A1011	10 x 11	202	115
JOT4601213	W43A1213	12 x 13	222	155
JOT4601415	W43A1415	14 x 15	245	245
JOT4601617	W43A1617	16 x 17	260	330
JOT4601819	W43A1819	18 x 19	280	414



JOT404S26H2 S26H2150		1/4" Dr. Spinner Handle	
Code	ItemNo.	S (Size)	l (mm)
JOT404S26H2	S26H2150	1/4"	145mm

Hand Tool Range



JOT200 - JOT212 R3702 - R3704		Quick Release Anti Slip Grip Reversible Ratchet Handle – 36 Teeth			
Code	Size	l (mm)	w (mm)	h (mm)	Weight (g)
JOT200 R2902	1/4" DR.	146	26	22	120
JOT212 R2903	3/8" DR.	185	32	30	265
JOT201 R2904	1/2" DR.	278	40	38	570



JOT205 – JOT206 R3702B – R3703B		Quick Release Anti Slip Grip Stubby Ratchet Handle, 48 Teeth			
Code	Drive	l (mm)	w (mm)	h (mm)	Weight (g)
JOT205 R3702B	1/4"	110	23	22	100
JOT206 R3703B	3/8"	142	30	29	225



JOT202 – JOT204 R3502 – R3504		Anti Slip Grip Ratchet Handle, 72 Teeth				
Code	Drive	l (mm)	w (mm)	h (mm)	Weight (g)	Torque (Nm)
JOT202 R3502	1/4"	135	25	24	140	68
JOT203 R3503	3/8"	199	34	35	300	245
JOT204 R3504	1/2"	250	42	43	580	647



JOT213 - JOT216 R3702 - R3704		Quick Release Anti-Slip Grip Reversible Ratchet Handle - 48 Teeth				
Code	Size	l (mm)	w (mm)	h (mm)	Weight (g)	Torque (Nm)
JOT214 R3702	1/4" DR.	135	23	22	115	68
JOT216 R3703	3/8" DR.	198	30	29	280	245
JOT213 R3704	1/2" DR.	253	42	38	620	647



JOT014 – JOT020 T21100N – T21050N		Micrometer Torque Wrenches, 48 Teeth		
Technical Data	Drive	Capacity Nm/ FT – lbs	Cuft	Weight (kg)
JOT020 T21101N	1/2"	20-100 N.m.	1	9
JOT015 T21200N	1/2"	40-200 N.m.	1.2	12.1
JOT019 T21340N	1/2"	60-340 N.m.	1	11
JOT017 T21025N	1/4"	5-25 N.m.	1	7.7
JOT018 T21750N	3/4"	150-750 N.m.	1	7.5
JOT016 T21025N	3/8"	5-25 N.m.	1	7.7
JOT014 T21100N	3/8"	20-100 N.m.	1.1	7.1

All torque wrenches are supplied calibrated and comes with a certificate



JOT218 R2902A		Ratchet Handle – 36 Teeth			
Code	Size	l (mm)	w (mm)	h (mm)	Weight (g)
JOT218 R2902A	1/4" DR.	125	26	22	128



JOT217 - JOT671R2804 R2803Q-R2803Q		Ratchet Handle – 48 Teeth			
Code	Size	l (mm)	w (mm)	h (mm)	Weight (g)
JOT217 R2803Q	3/8" DR.	200	30	35	228
JOT671R2804 R2804Q	1/2" DR.	250	36	43	509



JOT405ad R1206		3/4" Dr. Reversible Ratchet Handle, 24 Teeth	
Drive	l(mm)	Weight (kg)	
3/4"	500	1.8	



JOT443 S04H2125S		25 Pc 1/4" Dr. Socket Set
S04H2	11 Pc 1/4" Dr. Sockets :	4,5,5.5,6,7,8,9,10,11,12,13mm
S04HD2	9 Pc 1/4" Dr. Deep Sockets:	5,6,7,8,9,10,11,12,13mm
R3702	1 Pc 1/4" Dr. Ratchet Handle – 48 Teeth	
S24H2	2 Pc 1/4" Dr. Extension Bars 2" & 6"	
S26H2150	1 Pc Spinner Handle	

JOT400 S04H2118S		1/4" Dr. Socket Set 18 Pc
S04H2	12 Pc 1/4" Dr. 6 Point Sockets:	4,4.5,5,5.5,6,7,8,9,10,11,12,13mm
R2902	1 Pc 1/4" Dr. Ratchet Handle – 36 Teeth	
S24H2	2 Pc Extension Bars 2" and 4"	
S22H2130	1 Pc Flexible Handle 5"	
S23H2	1 Pc Sliding "T" Handle 4 – 1/2"	
S15H240	1 Pc Universal Joint	



JOT480 S04H3125S		25 Pc 3/8" Dr. Socket Set
S04H3	17 Pc 3/8" Dr. 6Pt Sockets: 6, 7, 8, 9, 10, 11, 12, 13, 14, 15, 16, 17, 18, 19, 20, 21, 22mm	
R3703	1 Pc 1-3/8" Dr. Ratchet Handle – 48 Teeth	
S24H3	2 Pc Extension Bars 3" & 6"	
S23H31200	1 Pc Slide T Bar	
S15H356	1 Pc Universal Joint	
S17H3	2 Pc Spark Plug 16 & 21mm	
(Ratchet available seperately - JOT216)		

JOT693 S04H3120S		20 Pc 3/8" Dr. Socket Set
S04H3	13 Pc - 3/8" Dr. Sockets:	6, 7, 8, 9, 10, 11, 12, 13, 14, 17, 19, 21, 23mm
S17H3121	1 Pc - Spark Plug 21mm	
R2903	1 Pc - 3/8" Dr. Ratchet Handle 36 Teeth	
S24H3	2 Pc - Extension Bars 3" and 6"	
S22H31200	1 Pc - Flexible Handle 8"	
S23H31200	1 Pc - Sliding T-Handle 8"	
S15H356	1 Pc - Universal Joint	



JOT462 S04H6415S		3/4" Dr. 12Pt Flank Socket Set (SAE) 15 Pc
R1206	1 Pc - 3/4" Dr. 500mm (20") Reversible Ratcheting Handle	
S23H6450	1 Pc - 3/4" Dr. 450mm (18") Sliding T-Bar	
S24H6100	1 Pc - 3/4" Dr. 100mm (4") Extension Bar	
S24H6200	1 Pc - 3/4" Dr. 200mm (8") Extension Bar	
S04H64	10 Pc - 3/4" Dr. 12Pt Sockets: 7/8", 15/16", 1", 1-1/8", 1-1/4", 1-7/16", 1-1/2" 1-5/8", 1-3/4", 2"	

JOT405 S04H6115SA		15 Pc 3/4" Dr. 6pt Flank Socket Set
R1206	1 Pc 3/4" Dr. 500mm (20") 24 Teeth Professional Ratchet Handle	
S23H6450	1 Pc 3/4" Dr. 450mm (18") Sliding "T" Bar	
S24H6100	1 Pc 3/4" Dr. 100mm (4") Extension Bar	
S24H6200	1 Pc 3/4" Dr. 200mm (8") Extension Bar	
S04H61	10 Pc 3/4" Dr. 6Pt Sockets: 22, 24, 27, 30, 32, 36, 38, 41, 46, 50mm	



JOT925 S05H2222S		22 Pc 1/4" Dr. Socket Set (Maxi Drive, Polish Finish) SAE
S05H22	11Pcs 1/4" Dr 6Pt Sockets: 5/32", 3/16", 7/32", 1/4", 9/32", 5/16", 11/32", 3/8", 7/16", 1/2", 9/16"	
S05HD22	7Pcs 1/4" Dr 6Pt Deep Sockets: 3/16", 1/4", 5/16", 3/8", 7/16", 1/2", 9/16"	
S24HC2	2Pcs 1/4" Dr 2" & 4" Extension Bars	
S34HC2150	1Pcs 1/4" Spinner Handle	
R2802Q	1Pcs 1/4" Dr 5-1/2" Quick Release Ratchet Handle, Snap On Type (48 Teeth)	

JOT927 S05H3224S		24 Pc 3/8" Dr. Socket Set (SAE)
S05H39	8Pcs 3/8" Dr 12Pt Sockets (CR-V): 3/8", 7/16", 1/2", 9/16", 5/8", 11/16", 3/4", 13/16"	
S05H38	8Pcs 3/8" Dr 12Pt Sockets (CR-V): 10, 11, 12, 13, 14, 15, 17, 19mm	
S05HD32	4Pc 3/8" Dr. 6Pt Deep Sockets (CR-V)" 1/2", 9/16", 11/16", 3/4"	
S24HC3	1Pc 3/8" Dr. 3" & 6" Extension Bar (CR-V)	
S17HC3216	1Pc 3/8" Dr. 5/8" Spark Plug Socket (CR-V)	
R2803Q	1Pc 3/8" Dr. 8" Quick Release Ratchet Handle, Snap On Type (48 Teeth)	



JOT692 S05H3918S		18 Pc 3/8" Dr. Socket Set (SAE)
S05H39	7 Pc - 3/8" Dr. 12Pt Sockets: 3/8", 7/16", 1/2", 9/16", 5/8", 11/16", 3/4"	
S05HD32	7 Pc - 3/8" Dr. 6Pt Deep Sockets: 3/8", 7/16", 1/2", 9/16", 5/8", 11/16", 3/4"	
S24HC375	1 Pc - 3/8" Dr. 3" Extension Bar	
S24HC3200	1 Pc - 3/8" Dr. 6" Extension Bar	
S17HC3216	1 Pc - 3/8" Dr. 5/8" Spark Plug Socket	
R2803Q	1 Pc - 3/8" Dr. Quick Release Ratchet, Snap on Type - 48 Teeth	

JOT670 S04H4728SC		28 Pc 1/2" Dr. Socket Wrench Set
S04H4	24 Pc - 1/2" Dr. Sockets 8mm - 34mm	
S24H4250	1 Pc - 1/2" Dr. 10" Extension Bar	
S23H41300	1 Pc - 1/2" Dr. 12" Sliding T Bar	
S15H472	1 Pc - 1/2" Dr. Universal Joint	
R3704	1 Pc - 1/2" Dr. 48 Teeth Quick Release Ratchet Handle	



JOT668 S04H4524S		24 Pc 1/2" Dr. Socket Wrench Set
S04H4	18 Pc - 1/2" Dr. Sockets: 10,11,12,13,14,15,16,17,1 8,19,20,21,22,23,24,27,30,32mm	
S15H472	1 Pc - Universal Joint	
R3704	1 Pc - 1/2" Dr. 48 Teeth Quick Release Ratchet Handle	
S24H4	2 Pc - Extension Bars 5" & 10"	
S22H41450	1 Pc - 15" Flexible Handle	
S23H41300	1 Pc - 12" Sliding T Handle	

JOT669 S04H4726S		26 Pc 1/2" Dr. Socket Wrench Set
S04H4	19 Pc - 1/2" Dr. Sockets: 12-34mm	
S41H4	1 Pc - 1/2" Dr. Speeder Handle	
S24H4	2 Pc - 1/2" Dr. Extension Bar 5" & 10"	
S23H41250	1 Pc - 1/2" Dr. Sliding T Bar	
S15H472	1 Pc - 1/2" Dr. Universal Joint	
R3704	1 Pc - 1/2" Dr. 48 Teeth Quick Release Ratchet Handle	
S17H4116	1 Pc - 1/2" Dr. 16mm Spark Plug Socket	



SOCKET & RATCHET SETS



JOT664 S04H3157SC	56 Pc 1/4" & 3/8" Dr. Flank Socket Wrench Set
S04H2	12 Pc – 1/4" Dr. Sockets: 4, 4.5, 5, 5.5, 6, 7, 8, 9, 10, 11, 12, 13mm
S04HD2	4 Pc – Deep Sockets: 8,10,12,13mm
	16 Pc – 1/4" Dr. Socket Bits: HEX: 3, 4, 5, 6mm STAR: T10, T15, T20, T25, T27, T30 SLOTTED: 4, 5.5, 7mm PHILLIPS: PH1, PH2, PH3
R3702	1 Pc – 1/4" Dr. 48 Teeth quick Release Ratchet Handle
S24H2	2 Pc – Extension Bars 2" & 6"
S16H302	1 Pc – Adapter for Extension 1/4" (M) x 3/8" (F)
S15H2	1 Pc – Universal Joint
S28H1	1 Pc – Spinner Handle
S04H3	8 Pc – Sockets: 14, 15, 17, 18, 19, 20, 22, 24mm
S04HD3	3 Pc – Deep Sockets: 14, 15, 17mm
R3703	1 Pc – 3/8" Dr. 48 Teeth Quick Release Ratchet Handle
S17H3	2 Pc – Spark Plug Sockets: 16,21mm
S15H356	1 Pc – Universal Joint
S16H403	1 Pc – Adaptor for Extension 1/2" (M) x 3/8" (F)
S24H3	2 Pc – Extension Bars 3" & 10"



JOT666 S04H4125S	25 Pc 1/2" Dr. 6Pt Flank Socket Wrench Set
S04H4	18 Pc – 1/2" Dr. Sockets: 10,11,12,13,14,15,16,17,18, 19,20,21,22,23,24,27,30,32mm
S17H4	2 Pc – Spark Plug sockets: 16 & 21mm
S24H4	2 Pc – Extension Bars: 5" & 10"
S23H4125	1 Pc – Sliding T Bar
S15H472	1 Pc – Universal Joint
R3704	1 Pc – 1/2" Dr. 48 Teeth Quick Release Ratchet Handle



JOT459	Torx Bit Socket Sets on Rail 1/4", 3/8" 1/2" 16 Pc
Tampereproof. Sizes: 1/4" (T6, T7, T8, T9), 3/8" (T10, T15, T20, T25, T27, T30, T40, T45, T50) 1/2" (T55, T60, T70)	



JOT929 S03V4120SC	20 Pc 1/2" Dr. 1000V Insulated Socket Set
<ul style="list-style-type: none"> • Anti Electro-shock • Handle insulation meets all requirements of the relevant international VDE standards 	
1000V 11 Pcs 1/2" Dr. 1000V Insulated Sockets: 10, 11, 12, 13, 14, 17, 19, 22, 24, 27, 32	
5Pc 1/2" Dr. 1000V Insulated Deep Hex Sockets H4, H5, H6, H8, H10	
1Pc 1/2" Dr. 1000V Insulated T-handle	
2Pc 1/2" Dr. 1000V Insulated Extension Bars	
1Pc 1/2" Dr. 1000V Insulated Ratchet Handle	



JOT446 S05H4213S	13 Pc 1/2" Dr. Socket Set (SAE)
Contents: 13 Pc 1/2" Dr. 12Pt SOCKETS (CR-V) : 3/8", 7/16", 1/2", 9/16", 5/8", 11/16", 3/4", 13/16", 7/8", 15/16", 1", 1-1/16", 1-1/8", + 1Pc Metal Clip Rail (L:370mm)	



JOT447 S05H3211S	11Pc 3/8" Dr. 12Pt Socket Set (SAE)
Contents: 11 Pc 12Pt SOCKETS (CR-V) : 1/4", 5/16", 3/8", 7/16", 1/2", 9/16", 5/8", 11/16", 3/4", 13/16", 7/8" + 1 Pc Metal Clip Rail	



JOT431 S06H414S	14 Pc 1/4" & 3/8" & 1/2" Dr. E Torx Socket Set
S06H2	5 Pc – 1/4" Dr. E4, E5, E6, E7, E8
S06H3	4 Pc – 3/8" Dr. E10, E11, E12, E14
S06H4	5 Pc – 1/2" Dr. E16, E18, E20, E22, E24



JOT458	Torx Bit Socket Sets on Rail 1/4", 3/8" 1/2" 16 Pc
Standard. Sizes: 1/4" (T6, T7, T8, T9); 3/8" (T10, T15, T20, T25, T27, T30, T40, T45, T50); 1/2" (T55, T60, T70.)	

Hand Tool Range



JOT433 - JOT435 MSH1214 - MSH3814		14 Pc Clip Rail
Item	Art. No	Type
JOT433	MSH1214	1/2" Dr.
JOT434	MSH1414	1/4" Dr.
JOT435	MSH3814	3/8" Dr.



JOT489 S29H2133S		33 Pc 1/4" Dr. Security Bit Set
1 Pc Magnetic Bit Holder (60mm)		
32 1/4" Security Bit (25mm)		
Torque Set: 6,8,10		
Tri-Wing: 1,2,3,4		
Spanner: 4,6,8,10		
Hex Security: 5/32", 9/14", 1/8", 7/64", 3/32", 5/64"		
Star Tamperproof: T-8H, T-10H, -15H, T-20H, T-25H, T-27H, T-30H, T-35H, T-40H		



JOT482 DBT31B		31 Pc Screwdriver Bit Set
3 Pc - Phillips: #1, #2, #3		
3 Pc - Slotted: 4x0.8, 5.5x1, 6.5x1.2		
6 Pc - Pozi: 1x2, 2x2, 3x2		
3Pc - Hexagon: 4, 5, 6		
15 Pc - Star: 10x2, 20x2, 40x2, 15x3, 25x3, 30x3		
1 Pc - 51mm Quick Release Bit Holder		



JOT481 S63H4507S		7 Pc 3/8" & 1/2" Dr. Ribe Bit Socket Set
4 Pc - 3/8" Dr. Ribe Bit Socket 90mm: M6;M7;M8;M10		
3 Pc - 1/2" Dr. Ribe Bit Socket 100mm: M12;M13;M14		



JOT4038 - JOT469 S39H3310 - S44H2UB		Bit Holders
Item	Art. No	Type
JOT4038	S39H3310	3/8" Dr. Bit Holder
JOT469	S44H2UB	1/4" Dr. Bit Holder

JOT408 S29H4140S		1/2" & 3/8" Dr. Power Bit Set 40 Pc		
Item	Art. No	Type	l	Size

JOT4080430	D130H40	Hex	30mm	4mm
JOT4080530	D130H50	Hex	30mm	5mm
JOT4080630	D130H60	Hex	30mm	6mm
JOT4080730	D130H70	Hex	30mm	7mm
JOT4080830	D130H80	Hex	30mm	8mm
JOT4081030	D130H100	Hex	30mm	10mm
JOT4081230	D130H120	Hex	30mm	12mm
JOT4080475	D176H40	Hex	75mm	4mm
JOT4080575	D176H50	Hex	75mm	5mm
JOT4080675	D176H60	Hex	75mm	6mm
JOT4080775	D176H70	Hex	75mm	7mm
JOT4080875	D176H80	Hex	75mm	8mm
JOT4081075	D176H100	Hex	75mm	10mm
JOT4081275	D176H120	Hex	75mm	12mm
JOT408T2030	D130T20	Star	30mm	T20
JOT408T2530	D130T25	Star	30mm	T25
JOT408T3030	D130T30	Star	30mm	T30
JOT408T4030	D130T40	Star	30mm	T40
JOT408T4530	D130T45	Star	30mm	T45
JOT408T5030	D130T50	Star	30mm	T50
JOT408T5530	D130T55	Star	30mm	T55
JOT408T2075	D175T20	Star	75mm	T20
JOT408T2575	D175T25	Star	75mm	T25
JOT408T3075	D175T30	Star	75mm	T30
JOT408T4075	D175T40	Star	75mm	T40
JOT408T4575	D175T45	Star	75mm	T45
JOT408T5075	D175T50	Star	75mm	T50
JOT408T5575	D175T55	Star	75mm	T55
JOT408M0530	D10M30M05A	Spline	30mm	M5
JOT408M0630	D10M30M06A	Spline	30mm	M6
JOT408M0830	D10M30M08A	Spline	30mm	M8
JOT408M1030	D10M30M10A	Spline	30mm	M10
JOT408M1230	D10M30M12A	Spline	30mm	M12
JOT408M0575	D10M75M05A	Spline	75mm	M5
JOT408M0675	D10M75M06A	Spline	75mm	M6
JOT408M0875	D10M75M08A	Spline	75mm	M8
JOT408M1075	D10M75M10A	Spline	75mm	M10
JOT408M1275	D10M75M12A	Spline	75mm	M12
JOT40812	S39H4310	1/2" Dr. Bit Holder		
JOT40838	S39H3310	3/8" Dr. Bit Holder		



JOT508a DB0141S-MQ		Magnetic Quick Release Bit Holder
Item	Art. No	Type
JOT508a	DB0141S-MQ	Bit Holder

BIT SETS

Hand Tool Range



BIT SETS

Hand Tool Range



JOT641 S29H4140SC	40 Pc 3/8" and 1/2" Dr. Power Bit Set
14 - 10 mm Hex Bits 30mm: 4, 5, 6, 7, 8, 10, 12 75mm: 4, 5, 6, 7, 8, 10, 12	
14 - 10 mm Star Bits 30mm: T20, T25, T30, T40, T45, T50, T55 75mm: T20, T25, T30, T40, T45, T50, T55	
10 - 10 mm Spline Bits 30mm: M5, M6, M8, M10, M12 75mm: M5, M6, M8, M10, M12	
2 Pc -Bit holders: 3/8" DR. x 10mm, 1/2" DR. x 10mm	
All items individually available. See JOT408.	



JOT484 S07H4118SP	18 Pc 1/2" Dr. Star Bit Socket Set
9 Pc - 55mm	T20, T25, T27, T30, T40, T45, T50, T55, T60
9 Pc - 100mm	T20, T25, T27, T30, T40, T45, T50, T55, T60



JOT479 S09H4118SP	18 Pc 1/2" Dr. Hex Bit Socket Set
9 Pc - 55mm	H5, H6, H7, H8, H10, H12, H14, H17, H19mm
9 Pc - 100mm	H5, H6, H7, H8, H10, H12, H14, H17, H19mm

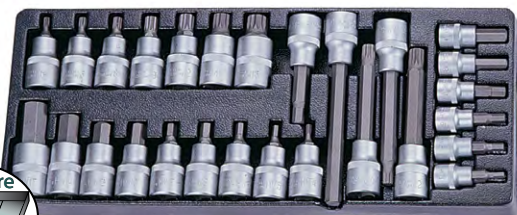

JOT673 S06H427SP	27 Pc 1/2" & 3/8" Dr. Socket Bit Set
S09H4	11 Pc 1/2" Dr. Hex Socket Bit
H15	10 Pc 1/2" Dr. Spline Socket Bit
S09H3	6 Pc 3/8" Dr. Hex Socket Bit



JOT483 S29H4215S	15 Pc 10mm Star Bit Set
7-10mm Star Bits: 30mm: T20, T25, T30, T40, T45, T50, T55 75mm: T20, T25, T30, T40, T45, T50, T55	
1-10mm 1/2" Dr. Bit Holder	



JOT476 S29H4115S	15 Pc 10mm Hex Bit Set
14-10mm Hex Bits: 30mm: 4, 5, 6, 7, 8, 10, 12 75mm: 4, 5, 6, 7, 8, 10, 12	
1-10mm 1/2" Dr. Bit Holder	



JOT488 S29H4111S	11Pc 10mm Spline Bit Set
10mm Spline Bits	
30mm: M5; M6; M8; M10; M12	
75mm: M5; M6; M8; M10; M12	



JOT43917 – JOT43922 S03AD4317 – S03AD4321	1/2" Dr. Thin Wall Deep Impact Socket				
Code	ItemNo.	Size (mm)	D (mm)	l (mm)	Wt (g)
JOT43917	S03AD4317	17	24	85	200
JOT43919	S03AD4319	19	26	85	210
JOT43921	S03AD4321	21	28	85	220
JOT43922	S03AD4322	22	30	85	240



JOT486 S05A408S	8 Pc 1/2" Dr. Hex Bit Impact Socket Set
CONTENTS:	
8 Pc - H5; H6; H8; H10; H12; H14; H17; H19	
(Each socket also available individually)	



JOT487 S06A408S	8 Pc 1/2" Dr. Torx Bit Impact Socket Set
CONTENTS:	
8 Pc - T30; T40; T45; T50; T55; T60; T70; T80	
(Each socket also available individually)	



JOT406 S03A4111S	11 Pc 1/2" Dr. 6Pt Flank Impact Socket Set (mm)
Contents:	11 Pc - 1/2" Dr. 6 pt. Flank Impact Sockets: 10, 11, 12, 13, 14, 16, 17, 19, 21, 22, 24mm



JOT448 S03A3112S	12 Pc 3/8" Dr. 6Pt Flank Impact Socket Set (mm)
Contents:	8, 9, 10, 11, 12, 13, 14, 15, 16, 17, 18, 19mm



JOT643 S03A4122SP	22 Pc 1/2" Dr. Impact Socket Set (mm)
11 Pc - 6 PT Flank Impact Socket Set 10; 11; 12; 13; 14; 16; 17; 19; 21; 22; 24mm	
11 Pc - 6 PT Flank Deep Impact Socket Set 10; 11; 12; 13; 14; 16; 17; 19; 21; 22; 24mm	



JOT642 S03A401SC	7 Pc 1/2" Dr. Impact Socket Accessory Set
1 Pc - Adaptor 3/8" F X 1/2" M	
2 Pc - Adaptor 1/2" F X 3/4" M, 1/2" F X 3/8" M	
1 Pc - 1/2" Dr. Universal Joint	
3 Pc - 1/2" Dr. Extension Bar; Length: 3", 5", 10"	



JOT45504 – JOT45508 S03A4E4 – S03A4E8			1/2" Dr. Extension Bars - Impact		
Code	ItemNo	Size	Ø (mm)	l (mm)	Weight (g)
JOT45504	S03A4E4	4"	25	100	200
JOT45508	S03A4E8	8"	25	150	340



JOT432 S03A4U4	1/2" Dr. Universal Joint		
Size	Ø (mm)	l (mm)	Weight (g)
1/2"	25	75	150

IMPACT SOCKETS

Hand Tool Range

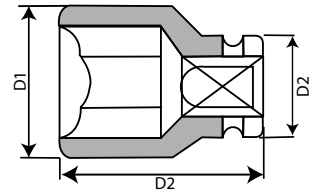
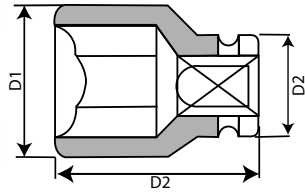

IMPACT SOCKETS

JOT43710 – JOT43732 S03A4110 – S03A4132			½" Dr. Impact Sockets			
Code	ItemNo	Size (mm)	D1 (mm)	D2 (mm)	l (mm)	Wt (g)
JOT43710	S03A4110	10	17.1	25	38	102
JOT43712	S03A4112	12	19.6	25	38	97
JOT43713	S03A4113	13	20.8	25	38	96
JOT43714	S03A4114	14	22.1	25	38	98
JOT43715	S03A4115	15	23.3	30	38	137
JOT43717	S03A4117	17	25.8	30	38	133
JOT43719	S03A4119	19	28.3	30	38	135
JOT43721	S03A4121	21	30.8	30	38	146
JOT43722	S03A4122	22	32.3	30	38	150
JOT43724	S03A4124	24	34.0	30	43	129
JOT43727	S03A4127	27	38.3	30	43	215
JOT43732	S03A4132	32	44.6	30	48	275

JOT43819 – JOT43850 S03A6119 – S03A6150			¾" Dr. Impact Sockets			
Code	ItemNo	Size (mm)	D1 (mm)	D2 (mm)	l (mm)	Wt (g)
JOT43819	S03A6119	19	32.6	44	50	375
JOT43827	S03A6127	27	42.6	44	53	395
JOT43830	S03A6130	30	46.4	44	53	420
JOT43832	S03A6132	32	48.9	44	56	468
JOT43835	S03A6135	35	52.7	44	56	512
JOT43836	S03A6136	36	53.9	44	56	526
JOT43838	S03A6138	38	56.4	44	57	565
JOT43840	S03A6140	40	58.9	44	57	611
JOT43841	S03A6141	41	60.1	44	57	622
JOT43846	S03A6146	46	66.4	44	62	772
JOT43850	S03A6150	50	71.4	54	72	1161

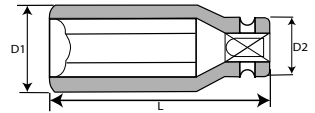
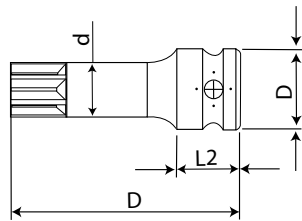

JOT487T30 - JOT487T80 S06A4T30 - S06A4T80			½" Dr. Star Bit Impact Sockets				
Code	ItemNo	Size	l (mm)	D (mm)	d (mm)	L2 (mm)	Wt (g)
JOT487T30	S06A4T30	T30	78	25	6.5	22.5	83
JOT487T40	S06A4T40	T40	78	25	7.5	22.5	91
JOT487T45	S06A4T45	T45	78	25	8.5	22.5	95
JOT487T50	S06A4T50	T50	78	25	9.5	22.5	101
JOT487T55	S06A4T55	T55	78	25	12.0	22.5	113
JOT487T60	S06A4T60	T60	78	25	14.0	22.5	128
JOT487T70	S06A4T70	T70	78	25	16.0	22.5	142
JOT487T80	S06A4T80	T80	78	25	18.0	22.5	158

JOT45610 – JOT45632 S03AD4110 – S03AD4132			½" Dr. 6Pt Flank Deep Impact Sockets			
Code	ItemNo.	Size (SAE)	D1 (mm)	D2 (mm)	l (mm)	Wt (g)
JOT45610	S03AD4110	10	17.1	25	78	140
JOT45611	S03AD4111	11	18.4	25	78	156
JOT45612	S03AD4112	12	19.6	25	78	162
JOT45613	S03AD4113	13	20.8	25	78	166
JOT45614	S03AD4114	14	22.1	25	78	157
JOT45616	S03AD4116	16	24.6	30	78	159
JOT45617	S03AD4117	17	25.8	30	78	185
JOT45619	S03AD4119	19		30	78	
JOT45621	S03AD4121	21	30.8	30	78	243
JOT45622	S03AD4122	22	32.2	30	78	243
JOT45624	S03AD4124	24	34.6	30	78	303
JOT45627	S03AD4127	27	38.3	30	78	351
JOT45630	S03AD4130	30	42	30	78	383
JOT45632	S03AD4132	32	44.6	30	78	415

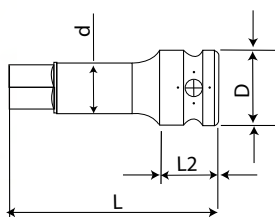

JOT486H5-JOT486H19 S05A4H5 - S05A4H19			½" Dr. Hex Bit Impact Socket					
Code	ItemNo	Size (mm)	Size	l (mm)	D (mm)	d (mm)	L2 (mm)	Wt (g)
JOT486H5	S05A4H5	H5		78	25	7	22.5	87
JOT486H6	S05A4H6	H6	1/4"	78	25	8	22.5	94
JOT486H8	S05A4H8	H8	5/16"	78	25	10.5	22.5	106
JOT486H10	S05A4H10	H10	3/8"	78	25	12.5	22.5	120
JOT486H12	S05A4H12	H12	7/16"	78	25	15	22.5	138
JOT486H14	S05A4H14	H14	1/2"	78	25	17.5	22.5	161
JOT486H17	S05A4H17	H17	9/16"	78	25	21	22.5	195
JOT486H19	S05A4H19	H19	5/8"	78	25	23	22.5	221

Hand Tool Range

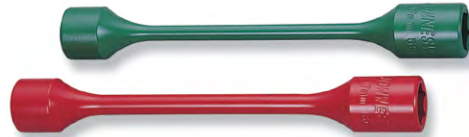

JOT467, JOT41716 & JOT41816 S47H401, S41H316 & S41H316			Speed Brace
Code	Article	Drive	Size
JOT467	S41H41	1/2"	16-1/4"
JOT41716	S41H316	3/8"	16"
JOT41816	S41H216	1/4"	16"

JOT47117 – JOT47121 S46TS11780 – S46TS12180			1/2" Dr. Wheel Torque Sockets		
Code	ItemNo	Size (mm)	Capacity	Colour	Wt
JOT47117	S46TS11780	17mm	80 ft.lbs / 108 Nm	Red	14g
JOT47119	S46TS11980	19mm	80 ft.lbs / 108 Nm	Blue	16g
JOT47121	S46TS12180	21mm	80 ft.lbs / 108 Nm	Orange	16g



JOT466 S27H2		1/4" Dr. Universal Spinner Handle	
Code	ItemNo.	S (Size)	l (mm)
JOT466	S26H2280	1/4"	280mm

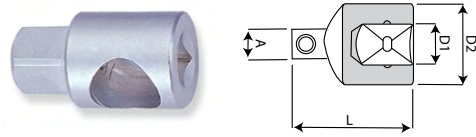

JOT451- JOT451b S16H302 - S16H304			Adapter for T Handle			
Code	ItemNo	S (Size)	A (mm)	D1 (mm)	D2 (mm)	l (mm)
JOT451	S16H302	1/4" (M) x 3/8" (F)	6.35	9.75	18.6	28
JOT451b	S16H304	1/2" (M) x 3/8" (F)	12.7	9.75	23.5	43.7
JOT401- S16H403	S16H403	3/8" (M) x 1/2" (F)	9.5	12.9	23.5	40

JOT491-JOT493 AG010184B-AG010184D		Flexible Shaft Nutdrivers
Code	ItemNo.	S (Size)
JOT491	AG010184B	6mm
JOT492	AG010184C	7mm
JOT493	AG010184D	8mm

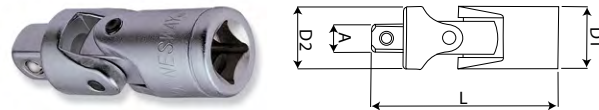

JOT4401 – JOT4403 S15H472 – S15H420			Universal Joints			
Code	ItemNo.	S (Size)	D1 (mm)	D2 (mm)	l (mm)	Weight (g)
JOT4401	S15H472	1/2"	25	25	69	150
JOT4402	S15H356	3/8"	18	18	49	70
JOT4403	S15H240	1/4"	14	14	35	30

JOT454145 S27H2		Flexible Extension Bars	
Code	ItemNo.	S (Size)	l (mm)
JOT454145	S27H2	1/4"	145mm



JOT4308 – JOT43017 S40H108 – S40H117			Sliding T-Handle Sockets				
Item	Art. No	S (mm)	D (mm)	D1 (mm)	L (mm)	L1 (mm)	Wt (g)
JOT4308	S40H108	8	12.5	10	300	200	300
JOT4309	S40H109	9	14	10	300	200	310
JOT43010	S40H110	10	14.8	10	300	200	320
JOT43011	S40H111	11	15.5	10	300	200	330
JOT43012	S40H112	12	16.8	10	300	200	340
JOT43013	S40H113	13	18	10	300	200	350
JOT43014	S40H114	14	19	10	300	200	350
JOT43017	S40H117	17	24	10	310	200	560

JOT46512 - JOT46513 S41H0812 - S41H0813			3 Way T-Handle Socket
Item	Art. No	Size	Length
JOT46512	S41H0812	8x10x12mm	140x130mm
JOT46513	S41H0813	8x10x13mm	140x130mm

EXTENSION BARS & ACCESSORIES

Hand Tool Range

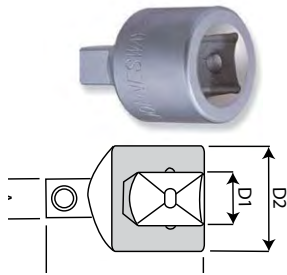

JOT401S16H1234-JOT401S16H3410 S16H1234 - S16H3410			Adapters			
Code	ItemNo	S (Size)	A (mm)	D1 (mm)	D2 (mm)	L (mm)
JOT401S16H1234	S16H1234	1/2" (F) x 3/4" (M)	19.05	12.7	27	45
JOT401S16H1034	S16H1034	1" (F) x 3/4" (M)	19.05	26	50	60
JOT401S16H3410	S16H3410	3/4" (F) x 1" (M)	25.3	19.05	39.7	360



JOT45203 – JOT45236 S24H4212 – S24H4236		Extension Bars	
Code	ItemNo.	S (Size)	L (mm)
JOT400b	S24H250	1/4"	50mm
JOT4503	S24H275	1/4"	75mm
JOT400a	S24H2100	1/4"	100mm
JOT454145	S27H2	1/4"	145mm
JOT66414	S24H2150	1/4"	152.5mm
JOT401S24H33	S24H375	3/8"	75mm
JOT480S24H32	S24H3150	3/8"	150mm
JOT454200	S24H3200	3/8"	200mm
JOT401S24H34	S24H3250	3/8"	255mm
JOT450	S24H3300	3/8"	300mm
JOT45315	S24H3215	3/8"	381mm
JOT45318	S24H3218	3/8"	458mm
JOT45320	S24H3220	3/8"	508mm
JOT45324	S24H3224	3/8"	610mm
JOT45330	S24H3230	3/8"	762mm
JOT45336	S24H3236	3/8"	915mm
JOT45203	S24H475	1/2"	76mm
JOT454125	S24H4125	1/2"	125mm
JOT454250	S24H4250	1/2"	250mm
JOT45215	S24H4215	1/2"	381mm
JOT45220	S24H4220	1/2"	508mm
JOT45224	S24H4224	1/2"	610mm
JOT45230	S24H4230	1/2"	762mm
JOT45236	S24H4236	1/2"	915mm
JOT405ac	S24H6100	3/4"	100mm
JOT405ab	S24H6200	3/4"	200mm

JOT45708 - JOT45716 JOT405ac - JOT405ab S24H6100 - S24H6400			3/4" Dr. Extension Bar	
Item	Art. No	S (size)	L (mm)	Weight (g)
JOT405ac	S24H6100	3/4"	100	426
JOT45708	S24H6150	3/4"	150	558
JOT405ab	S24H6200	3/4"	200	734
JOT45716	S24H6400	3/4"	400	1386



JOT444 S28H08S	8 Pc Extension Bar Set
Contents	
S28H	3 Pc – 1/4" Dr. 2", 3" & 6" Extension Bars
	2 Pc – 3/8" Dr. 3" & 6" Extension Bars
	3 Pc – 1/2" Dr. 3", 5" & 10" Extension Bars



JOT445 S37H106S	6 Pc Wobble Extension Bar Set
Contents	
S37H2	2 Pc – 1/4" Dr. Extension Bars 2" & 4"
S37H3	2 Pc – 3/8" Dr. Extension Bars 3" & 6"
S37H4	2 Pc – 1/2" Dr. Extension Bars 5" & 10"



JOT47038 S60H3104S	4 Pc 3/8" Dr. Lock Extension Bar Set
Contents: 3", 6", 10", 18"	



JOT429 S22H41600		Flexible Handle 600 mm		
Code	ItemNo.	Size (Inch)	L (mm)	Weight (g)
JOT429	S22H41600	1/2"	600	465

JOT428 S22H41450		Flexible Handles		
Code	ItemNo.	Size (Inch)	L (mm)	Weight (g)
JOT428	S22H41450	1/2"	450mm	790
JOT400S22H130	S22H21130	1/4"	130mm	96
JOT400S22H150	S22H21150	1/4"	150mm	186
JOT668a	S22H41375	1/2"	375mm	696



JOT663 P60105SP		5 Pc Mechanic Tool Set
S23H41300	1 Pc – ½" Dr. Sliding T-Bar, l:300mm	
S24H4	2 Pc – ½" Dr. Extension Bar, l:125,250mm	
AI060020	1 Pc – Feeler Gauges 20 Blades	
P6008	1 Pc – 8" Slip Joint Plier	



JOT461 - JOT405aa S23H41300 - S23H6450		Sliding T-bar		
Code	ItemNo.	Size (Inch)	l (mm)	Weight (g)
JOT400S23H	S23H21130	1/4"	130	48
JOT480S24H33	S23H31200	3/8"	200	157
JOT461	S23H41300	1/2"	300	465
JOT6661	S23H41250	1/2"	250	440
JOT405aa	S23H6450	3/4"	450	1213

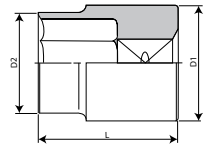
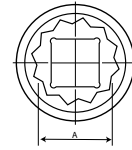

JOT48506 - JOT48555 S05H2306 - S65H2355		1/4" Dr. 12Pt Sockets (SAE)
Item	Art. No	Size
JOT48506	S05H2306	1/4"
JOT48508	S05H2308	5/16"
JOT48510	S05H2310	3/8"
JOT48511	S05H2311	7/16"
JOT48513	S05H2313	1/2"
JOT48555	S05H2355	7/32"

JOT44701 - JOT44711 S05H3906 - S05H3911		3/8" Dr. 12Pt Sockets (SAE)				
Item	Art. No	A (size)	D1 (mm)	D2 (mm)	L (mm)	Wt (g)
JOT44701	S05H3906	1/4"	16.7	10	28	20
JOT44702	S05H3908	5/16"	16.8	11.8	28	20
JOT44703	S05H3910	3/8"	17.8	14	28	20
JOT44704	S05H3911	7/16"	17.8	16	28	20
JOT44705	S05H3913	1/2"	18.9	18.9	28	35
JOT44706	S05H3914	9/16"	19.7	19.7	28	30
JOT44707	S05H3916	5/8"	22.2	22.2	28	40
JOT44708	S05H3917	11/16"	23.8	23.8	30	50
JOT44709	S05H3919	3/4"	25.8	25.8	30	70
JOT44710	S05H3921	13/16"	27.8	27.8	32	80
JOT44711	S05H3922	7/8"	30	30	32	100

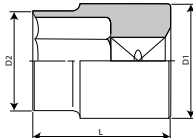
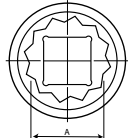

JOT47810 - JOT47819 S05H4810 - S05H4819		1/2" Dr. 12Pt Sockets (mm)				
Item	Art. No	A (size)	D1 (mm)	D2 (mm)	L (mm)	Wt (g)
JOT47810	S05H4810	10	21.8	15.4	38	60
JOT47812	S05H4812	12	21.8	18	38	60
JOT47813	S05H4813	13	21.8	19	38	60
JOT47814	S05H4814	14	22	20.3	38	60
JOT47815	S05H4815	15	22	22	38	60
JOT47816	S05H4816	16	22	22	38	60
JOT47817	S05H4817	17	23.7	23.8	38	70
JOT47818	S05H4818	18	24.8	24.8	38	70
JOT47819	S05H4819	19	25.8	25.8	38	80
JOT47820	S05H4820	20	27.9	27.9	38	100
JOT47821	S05H4821	21	27.8	28.8	38	90
JOT47822	S05H4822	22	30	30	38	120
JOT47823	S05H4823	23			38	
JOT47824	S05H4824	24	31.8	31.8	38	120
JOT47825	S05H4825	25			38	
JOT47826	S05H4826	26			38	
JOT47827	S05H4827	27			38	
JOT47828	S05H4828	28			38	
JOT47829	S05H4829	29			38	
JOT47830	S05H4830	30			38	



JOT44601 - JOT44613 S05H4910 - S09H4929		1/2" Dr. 12Pt Sockets (SAE)				
Item	Art. No	A (size)	D1 (mm)	D2 (mm)	L (mm)	Wt (g)
JOT44601	S66H4210	3/8"	21.8	14	38	50
JOT6714911	S05H4911	7/16"	21.8	16.7	38	60
JOT6714913	S05H4913	1/2"	21.8	18.8	38	80
JOT6714914	S05H4914	9/16"	22	20.5	38	100
JOT6714916	S05H4916	5/8"	22	22	38	110
JOT6714917	S05H4917	11/16"	23.8	23.8	38	120
JOT6714919	S05H4919	3/4"	26	26	38	150
JOT6714921	S05H4921	13/16"	28	28	38	160
JOT6714922	S05H4922	7/8"	29.8	29.8	38	115
JOT6714924	S05H4924	15/16"	31.8	31.8	38	120
JOT44611	S66H4226	1"	33.7	33.7	38	150
JOT44612	S66H4227	1 1/16"	35.7	35.7	42	160
JOT44613	S66H4229	1 1/8"	37.7	37.7	42	190

SOCKETS - INDIVIDUALLY AVAILABLE

Hand Tool Range



SOCKETS - INDIVIDUALLY AVAILABLE

JOT4181132 - JOT418932 S65HD2209 - S65HD2207		1/4" Dr. 12Pt Deep Sockets (SAE)
Item	Art. No	Size
JOT4181132	S65HD2209	11/32"
JOT41812	S65HD2213	1/2"
JOT41814	S65HD2206	1/4"
JOT41838	S65HD2210	3/8"
JOT418516	S65HD2208	5/16"
JOT418716	S65HD2211	7/16"
JOT418916	S65HD2214	9/16"
JOT418932	S65HD2207	9/32"

JOT41712 - JOT41796 S65H3213 - S65H3208		3/8" Dr. 12Pt Deep Sockets (SAE)
Item	Art. No	Size
JOT41712	S65H3213	1/2"
JOT41714	S65H3208	1/4"
JOT41738	S65H3210	3/8"
JOT41758	S65H3216	5/8"
JOT41776	S65H3211	7/16"
JOT41778	S65H3222	7/8"
JOT41796	S65H3214	9/16"

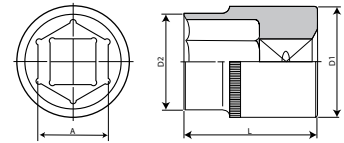
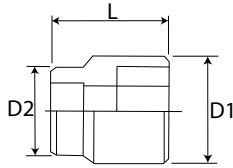

JOT45722 - JOT45750 S04H6422 - S04H6450		3/4" Dr. 12Pt Flank Sockets				
Item	Art. No	S (size)	L (mm)	D1 (mm)	D2 (mm)	Wt (g)
JOT45722	S04H6422	7/8"	49.5	33	36	220
JOT45724	S04H6424	15/16"	49.5	35	36	220
JOT45726	S04H6426	1"	50	37	36	220
JOT45727	S04H6427	1-1/16"	52	38	36	220
JOT45729	S04H6429	1-1/8"	53	40	38	237
JOT45730	S04H6430	1-3/16"	54	42	38	262
JOT45732	S04H6432	1-1/4"	56	44	38	281
JOT45733	S04H6433	1-5/16"	56	46	38	312
JOT45735	S04H6435	1-3/8"	58	48	42	358
JOT45736	S04H6436	1-7/16"	58	50	42	400
JOT45738	S04H6438	1-1/2"	60	52	45	450
JOT45741	S04H6441	1-5/8"	64	56	45	537
JOT45744	S04H6444	1-3/4"	64	56	45	537
JOT45746	S04H6446	1-13/16"	68	62	48	650
JOT45747	S04H6447	1-7/8"	68	62	48	650
JOT45750	S04H6450	2"	72	68	48	783

JOT4094 - JOT40914 S04H2104 - S04H2114		1/4" Dr. 6Pt Flank Sockets					
Item	Art. No	Size (mm)	D1 (mm)	D2 (mm)	T (mm)	L (mm)	Wt (g)
JOT4094	S04H2104	4	6.8	11.8	7	25	9.5
JOT40945	S04H21045	4.5	7.3	11.8	9	25	9.9
JOT4095	S04H2105	5	8	11.8	9	25	9.9
JOT40955	S04H21055	5.5	8.6	11.8	9	25	10
JOT4096	S04H2106	6	9.2	11.8	9	25	10
JOT4097	S04H2107	7	10.5	11.8	9	25	11
JOT4098	S04H2108	8	11.7	11.4	9	25	11
JOT4099	S04H2109	9	12.7	11.6	9	25	12
JOT40910	S04H2110	10	13.7	12.8	9	25	18
JOT40911	S04H2111	11	15.7	14.4	9	25	22
JOT40912	S04H2112	12	16.6	13.7	9	25	23
JOT40913	S04H2113	13	17.6	13.9	9	25	24
JOT40914	S04H2114	14	20	17.5	9	25	29

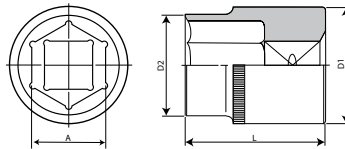

JOT4116 - JOT41124 S04H3106 - S04H3124		3/8" Dr. 6Pt Flank Sockets					
Item	Art. No	S (mm)	D1 (mm)	D2 (mm)	T (mm)	L (mm)	(g)
JOT4116	S04H3106	6	9.6	16.8	6	28	24
JOT4117	S04H3107	7	10.7	16.8	6	28	24
JOT4118	S04H3108	8	12	16.8	8	28	24
JOT4119	S04H3109	9	13.3	16.8	8	28	24
JOT41110	S04H3110	10	14.4	16.8	8	28	24
JOT41111	S04H3111	11	15.8	16.8	8	28	24
JOT41112	S04H3112	12	16.8	16	9	28	24
JOT41113	S04H3113	13	19	18	9	28	24

Item	Art. No	S (mm)	D1 (mm)	D2 (mm)	T (mm)	L (mm)	(g)
JOT41114	S04H3114	14	19.7	18.8	10	28	30
JOT41115	S04H3115	15	20.8	19.8	10	28	40
JOT41116	S04H3116	16	22	20.8	10	28	40
JOT41117	S04H3117	17	23.8	22	10	28	56
JOT41118	S04H3118	18	25.7	24.1	12	28	58
JOT41119	S04H3119	19	25.7	24.1	12	28	60
JOT41120	S04H3120	20	27.6	25	12	32	70
JOT41121	S04H3121	21	27.6	25	14	32	76
JOT41122	S04H3122	22	29.6	27.8	14	32	76
JOT41124	S04H3124	24	31	29.8	16	32	112

Hand Tool Range

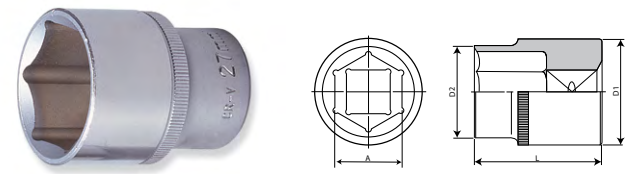
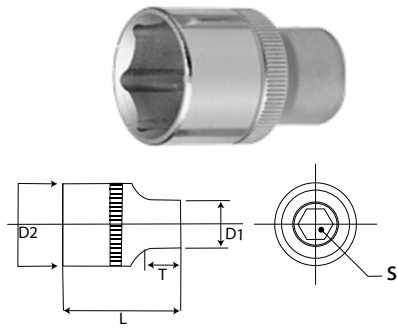

**JOT405ae - JOT405an
S04H6122 - S04H6150** **3/4" Dr. 6Pt Flank Sockets**

Item	Art. No	S (mm)	D1 (mm)	D2 (mm)	L (mm)	Wt (g)
JOT405ae	S04H6122	22	33	36	49.5	220
JOT405af	S04H6124	24	35	36	49.5	220
JOT405ag	S04H6127	27	38	36	52	220
JOT405ah	S04H6130	30	42	38	54	262
JOT405ai	S04H6132	32	44	38	56	281
JOT405aj	S04H6136	36	50	42	58	400
JOT405ak	S04H6138	38	52	45	60	450
JOT405al	S04H6141	41	56	45	64	537
JOT405am	S04H6146	46	62	48	68	650
JOT405an	S04H6150	50	68	48	72	783

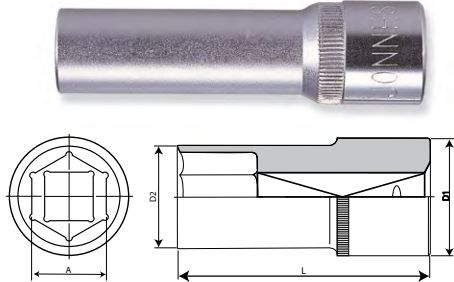

**JOT4148 - JOT41432
S04HD4108 - S04HD4132** **1/2" Dr. 6Pt Flank Deep Sockets**

Item	Art. No	S (mm)	D1 (mm)	D2 (mm)	T (mm)	L (mm)	Wt (g)
JOT4148	S04HD4108	8	12.7	21.8	9	76	114
JOT4149	S04HD4109	9	14.3	21.8	9	76	114
JOT41410	S04HD4110	10	15.4	21.8	10	76	114
JOT41411	S04HD4111	11	16.7	21.8	12	76	114
JOT41412	S04HD4112	12	18	21.8	13	76	114
JOT41413	S04HD4113	13	19	21.8	14	76	118
JOT41414	S04HD4114	14	20.3	22	15	76	130
JOT41415	S04HD4115	15	21.3	22	16	76	136
JOT41416	S04HD4116	16	23	22	17	76	138
JOT41417	S04HD4117	17	23.8	23	18	76	144
JOT41418	S04HD4118	18	24.8	23	19	76	150
JOT41419	S04HD4119	19	25.8	24	20	76	178
JOT41420	S04HD4120	20	28	24	21	76	180
JOT41421	S04HD4121	21	29	24	23	76	190
JOT41422	S04HD4122	22	30	26	27	76	240
JOT41424	S04HD4124	24	31.8	28	27	76	250
JOT41427	S04HD4127	27	35.7	28	28	76	320
JOT41430	S04HD4130	30	39.8	34	34	76	324
JOT41432	S04HD4132	32	42	36	34	76	390

**JOT4138 - JOT41332
S04H4108 - S04H4132** **1/2" Dr. 6Pt Flank Sockets**

Item	Art. No	S (mm)	D1 (mm)	D2 (mm)	T (mm)	L (mm)	(g)
JOT4138	S04H4108	8	13.8	21.8	8	38	50
JOT4139	S04H4109	9	14.3	21.8	8	38	50
JOT41310	S04H4110	10	15.4	21.8	9	38	50
JOT41311	S04H4111	11	16.7	21.8	9	38	50
JOT41312	S04H4112	12	18	21.8	9	38	53
JOT41313	S04H4113	13	19	21.8	10	38	55
JOT41314	S04H4114	14	20.3	22	12	38	55
JOT41315	S04H4115	15	21.3	22	12	38	55
JOT41316	S04H4116	16	23.3	22	12	38	60
JOT41317	S04H4117	17	23.8	23	12	38	67
JOT41318	S04H4118	18	24.8	23.5	12	38	71
JOT41319	S04H4119	19	27	24	12	38	84
JOT41320	S04H4120	20	28	24	12	38	87
JOT41321	S04H4121	21	29	24	12	38	90
JOT41322	S04H4122	22	30	28	14	38	98
JOT41323	S04H4123	23	30.7	28	14	38	115
JOT41324	S04H4124	24	31.8	28	16	38	125
JOT41327	S04H4127	27	35.7	28	18	42	165
JOT41330	S04H4130	30	39.8	34	20	42	200
JOT41332	S04H4132	32	42	36	22	42	240
JOT41334	S04H4134	34	45	40	24	48	280
JOT41336	S04H4136	36	42	48	24	48	333

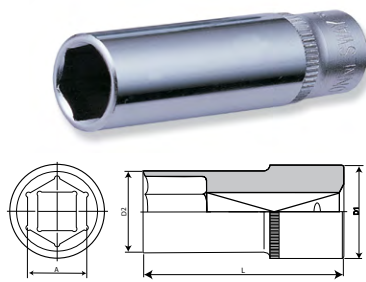

**JOT4104 - JOT41013
S04HD2104 - S04HD2113** **1/4" Dr. 6Pt Flank Deep Sockets**

Item	Art. No	S (mm)	D1 (mm)	D2 (mm)	T (mm)	L (mm)	Wt (g)
JOT4104	S04HD2104	4	8	12	20	50	20
JOT41045	S04HD21045	4.5	8	12	20	50	20
JOT4105	S04HD2105	5	8	12	20	50	20
JOT41055	S04HD21055	5.5	8.6	12	20	50	20
JOT4106	S04HD2106	6	9.2	12	20	50	20
JOT4107	S04HD2107	7	10.5	12	20	50	22
JOT4108	S04HD2108	8	12	11.5	20	50	22
JOT4109	S04HD2109	9	13.1	12.4	20	50	28
JOT41010	S04HD2110	10	14.4	13.3	20	50	34
JOT41011	S04HD2111	11	15.9	14.8	20	50	56
JOT41012	S04HD2112	12	17	15.8	20	50	60
JOT41013	S04HD2113	13	17.8	16.8	20	50	66

SOCKETS - INDIVIDUALLY AVAILABLE

Hand Tool Range



SOCKETS - INDIVIDUALLY AVAILABLE

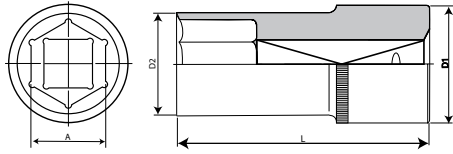

**JOT4126 – JOT41224
S04HD3106 –
S04HD41224** **3/8" Dr. 6Pt Flank
Deep Sockets**

Item	Art. No	S (mm)	D1 (mm)	D2 (mm)	T (mm)	L (mm)	Wt (g)
JOT4126	S04HD3106	6	9.8	16.8	7	63	43
JOT4127	S04HD3107	7	10.8	16.8	7	63	45
JOT4128	S04HD3108	8	12	16.8	8	63	50
JOT4129	S04HD3109	9	13.3	16.8	9	63	60
JOT41210	S04HD3110	10	14.4	17	9	63	60
JOT41211	S04HD3111	11	15.8	17	10	63	60
JOT41212	S04HD3112	12	17.7	17	12	63	66
JOT41213	S04HD3113	13	19	18	12	63	76
JOT41214	S04HD3114	14	19.7	18.8	15	63	80
JOT41215	S04HD3115	15	20.8	19.8	15	63	90
JOT41216	S04HD3116	16	22	20.8	15	63	92
JOT41217	S04HD3117	17	23.8	22.8	15	63	110
JOT41218	S04HD3118	18	26	23.8	18	63	125
JOT41219	S04HD3119	19	26	23.8	18	63	130
JOT41220	S04HD3120	20	27.8	24.8	18	63	140
JOT41221	S04HD3121	21	28	25.8	18	63	150
JOT41222	S04HD3122	22	30	27.8	21	63	168
JOT41224	S04HD3124	24	32	28	21	63	193



JOT48106 - JOT48114 S63H3306 - S63H4314		Ribe Bits Socket		
Item	Art. No	Drive	Size	l (mm)
JOT48106	S63H3306	3/8"	M6	90
JOT48107	S63H3307	3/8"	M7	90
JOT48108	S63H3308	3/8"	M8	90
JOT48110	S63H3310	3/8"	M10	90
JOT48112	S63H4312	1/2"	M12	100
JOT48113	S63H4313	1/2"	M13	100
JOT48114	S63H4314	1/2"	M14	100



JOT673M10110 - JOT673M855 S49H4310 - S49H4108		1/2" Dr. Multi Spline Socket Bit	
Item	Art. No	Size	l (mm)
JOT673M555	S49H4105	M5	55
JOT673M655	S49H4106	M6	55
JOT673M855	S49H4108	M8	55
JOT673M1055	S49H4110	M10	55
JOT673M1255	S49H4112	M12	55
JOT673M1455	S49H4114	M14	55
JOT673M1655	S49H4116	M16	55
JOT673M8120	S49H4308	M8	110
JOT673M10110	S49H4310	M10	110
JOT673M12110	S49H4312	M12	110

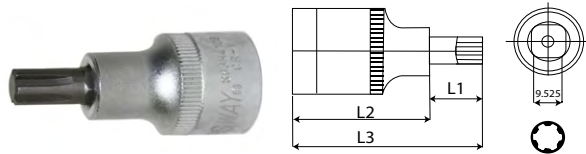

JOT47208 S63H4108		Ribe Bit Socket		
Drive	Size	l1 (mm)	l2 (mm)	l3 (mm)
3/8"	M8	16.5	55	37

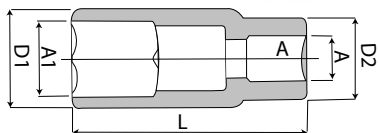
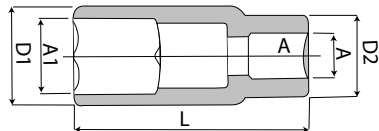

JOT42614 & JOT42621 S17H3116 & S17H3121		3/8" Dr. Spark Plug Sockets					
Code	ItemNo	S (Size)	A (mm)	D1 (mm)	D2 (mm)	L (mm)	Weight (g)
JOT42614	S17H3414	3/8" Dr. 14mm	9.525	20	20	90	90
JOT42616	S17H3116	3/8" Dr. 16mm	9.525	16	22	19	64
JOT42621	S17H3121	3/8" Dr. *21mm	9.525	21	27.8	21.4	64

JOT42716 & JOT42721 S17H4116 & S17H4121		1/2" Dr. Spark Plug Sockets					
Code	ItemNo	S (Size)	A (mm)	D1 (mm)	D2 (mm)	L (mm)	Weight (g)
JOT42716	S17H4116	1/2" Dr. 16mm	12.7	16	22	22	64
JOT42721	S17H4121	1/2" Dr. 21mm	12.7	21	27.8	23.2	64

Hand Tool Range



SOCKETS - INDIVIDUALLY AVAILABLE

Hand Tool Range

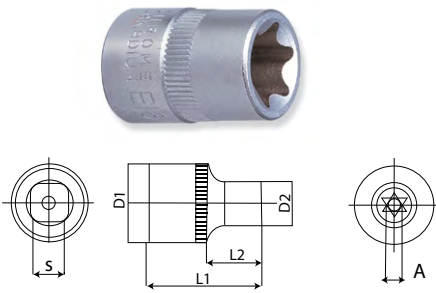

JOT431416 – JOT431424 S06H416 – S06H424		1/2" Dr. Female Star Sockets						
Code	ItemNo.	A (Size)	S (mm)	D1 (mm)	D2 (mm)	L1 (mm)	L2 (mm)	Weight (g)
JOT431416	S06H416	E16	12.7	22	18.8	38	17	55
JOT431418	S06H418	E18	12.7	22	20.8	38	17	80
JOT431420	S06H420	E20	12.7	22	23	38	17	90
JOT431422	S06H422	E22	12.7	22	25	38	17	93
JOT431424	S06H424	E24	12.7	22	27	38	17	111

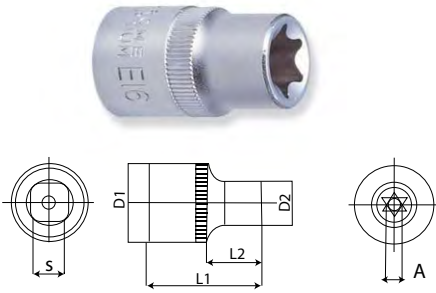

JOT4418 – JOT44120 S06H308 – S06H320		3/8" Dr. Female Star Sockets						
Code	ItemNo.	A (Size)	S (mm)	D1 (mm)	D2 (mm)	L1 (mm)	L2 (mm)	Weight (g)
JOT4418	S06H308	E8	9.525	17	11.2	28	12	24
JOT44110	S06H310	E10	9.525	17	13.2	28	12	25
JOT44111	S06H311	E11	9.525	17	13.8	28	12	25
JOT44112	S06H312	E12	9.525	17	14.8	28	12	26
JOT44114	S06H314	E14	9.525	18	16.8	28	12	33
JOT44116	S06H316	E16	9.525	20	18.8	28	12	43
JOT44118	S06H318	E18	9.525	22	20.8	28	12	53
JOT44120	S06H320	E20	9.525	24	22.8	28	12	61

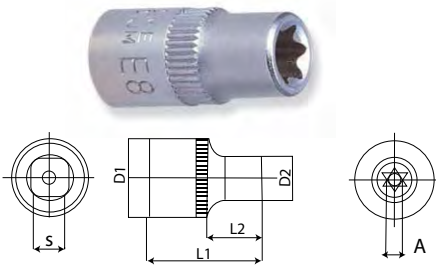

JOT431204 - JOT431208 S06H204 - S06H208		1/4" Dr. 6Pt Star Socket						
Item	Art. No	A (size)	S (mm)	D1 (mm)	D2 (mm)	L1 (mm)	L2 (mm)	Weight (g)
JOT431204	S06H204	E4	6.350	12	6.2	25	11	10
JOT431205	S06H205	E5	6.350	12	7.2	25	11	10
JOT431206	S06H206	E6	6.350	12	8.2	25	11	11
JOT431207	S06H207	E7	6.350	12	9	25	11	11
JOT431208	S06H208	E8	6.350	12	10.3	25	11	12

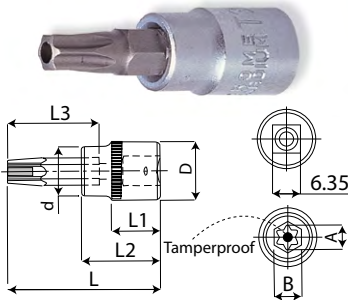

JOT4196 – JOT4199 S08H206 – S08H209		1/4" Dr. Torx Bit Sockets (Tamperproof)								
Item	Art. No	A (Size)	L3 (mm)	B (mm)	L (mm)	D (mm)	D (mm)	L1 (mm)	L2 (mm)	Wt (g)
JOT4196	S08H206	T6	25	6.3	37	12	10.8	13	21	14
JOT4197	S08H207	T7	25	6.3	37	12	10.8	13	21	14
JOT4198	S08H208	T8	25	6.3	37	12	10.8	13	21	14
JOT4199	S08H209	T9	25	6.3	37	12	10.8	13	21	14

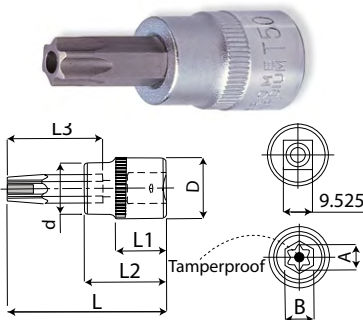

JOT42010 – JOT42050 S08H310 – S08H350		3/8" Dr. Torx Bit Sockets (Tamperproof)								
Item	Art. No	A (Size)	L3 (mm)	B (mm)	L (mm)	D (mm)	D (mm)	L1 (mm)	L2 (mm)	Wt (g)
JOT42010	S08H310	T10	30	6.3	48	18	13.8	15.5	26.5	36
JOT42015	S08H315	T15	30	6.3	48	18	13.8	15.5	26.5	36
JOT42020	S08H320	T20	30	6.3	48	18	13.8	15.5	26.5	36
JOT42025	S08H325	T25	30	6.3	48	18	13.8	15.5	26.5	36
JOT42027	S08H327	T27	30	6.3	48	18	13.8	15.5	26.5	36
JOT42030	S08H330	T30	30	6.3	48	18	13.8	15.5	26.5	36
JOT42040	S08H340	T40	30	7.88	48	18	15.8	15.5	26.5	38
JOT42045	S08H345	T45	30	7.88	48	18	15.8	15.5	26.5	42
JOT42050	S08H350	T50	30	7.88	48	18	15.8	15.5	26.5	42

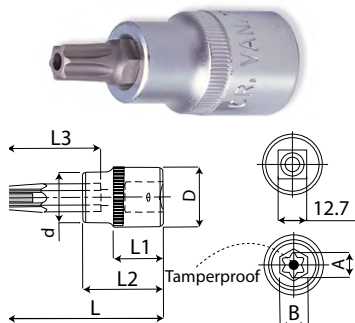

JOT42155 – JOT42170 S08H455 – S08H470		1/2" Dr. Torx Bit Sockets (Tamperproof)								
Item	Art. No	A (Size)	L3 (mm)	B (mm)	L (mm)	D (mm)	D (mm)	L1 (mm)	L2 (mm)	Wt (g)
JOT42155	S08H455	T55	30	10	55	22	17.8	20	36	82
JOT42160	S08H460	T60	30	12	55	24	20.8	20	36	112
JOT42170	S08H470	T70	30	12	55	24	20.8	20	36	114



SOCKETS - INDIVIDUALLY AVAILABLE

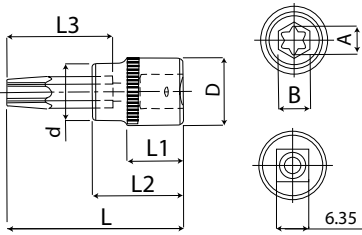

JOT4156 - 41530 S07H206 – S07H230		1/4" Dr. Torx Bit Sockets								
Item	Art. No	A (Size)	L3 (mm)	B (mm)	L (mm)	D (mm)	d (mm)	L1 (mm)	L2 (mm)	Wt (g)
JOT4156	S07H206	T6	25	6.3	37	12	10.8	13	21	14
JOT4157	S07H207	T7	25	6.3	37	12	10.8	13	21	14
JOT4158	S07H208	T8	25	6.3	37	12	10.8	13	21	14
JOT4159	S07H209	T9	25	6.3	37	12	10.8	13	21	14
JOT41510	S07H210	T10	25	6.3	37	12	10.8	13	21	14
JOT41515	S07H215	T15	25	6.3	37	12	10.8	13	21	14
JOT41520	S07H220	T20	25	6.3	37	12	10.8	13	21	14
JOT41525	S07H225	T25	25	6.3	37	12	10.8	13	21	14
JOT41527	S07H227	T27	25	6.3	37	12	10.8	13	21	14
JOT41530	S07H230	T30	25	6.3	37	12	10.8	13	21	14

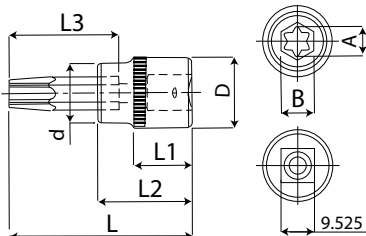

JOT41610 – JOT41650 S07H310 – S07H350		3/8" Dr. Torx Bit Sockets								
Item	ItemNo	A (Size)	L3 (mm)	B (mm)	L (mm)	D (mm)	d (mm)	L1 (mm)	L2 (mm)	Wt (g)
JOT41610	S07H310	T10	30	6.3	48	18	13.8	15.5	26.5	36
JOT41615	S07H315	T15	30	6.3	48	18	13.8	15.5	26.5	36
JOT41620	S07H320	T20	30	6.3	48	18	13.8	15.5	26.5	36
JOT41625	S07H325	T25	30	6.3	48	18	13.8	15.5	26.5	36
JOT41627	S07H327	T27	30	6.3	48	18	13.8	15.5	26.5	36
JOT41630	S07H330	T30	30	6.3	48	18	13.8	15.5	26.5	36
JOT41640	S07H340	T40	30	7.88	48	18	15.8	15.5	26.5	38
JOT41645	S07H345	T45	30	7.88	48	18	15.8	15.5	26.5	42
JOT41650	S07H350	T50	30	7.88	48	18	15.8	15.5	26.5	46

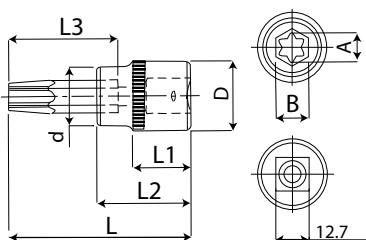

JOT41720 – JOT41770 S07H420 – S07H470		1/2" Dr. Torx Bit Sockets								
Art. No	ItemNo	A (Size)	L3 (mm)	B (mm)	L (mm)	D (mm)	d (mm)	L1 (mm)	L2 (mm)	Wt (g)
JOT41720	S07H420	T20	30	7.88	55	22	15	20	38	70
JOT41725	S07H425	T25	30	7.88	55	22	15	20	38	70
JOT41727	S07H427	T27	30	7.88	55	22	15	20	38	70
JOT41730	S07H430	T30	30	7.88	55	22	15	20	38	70
JOT41740	S07H440	T40	30	7.88	55	22	15	20	38	72
JOT41745	S07H445	T45	30	7.88	55	22	15	20	38	72
JOT41750	S07H450	T50	30	7.88	55	22	15	20	38	76
JOT41755	S07H455	T55	30	10	55	22	17	20	38	84
JOT41760	S07H460	T60	30	12	55	24	22	20	38	114
JOT41770	S07H470	T70	30	14	55	24	22	20	38	116

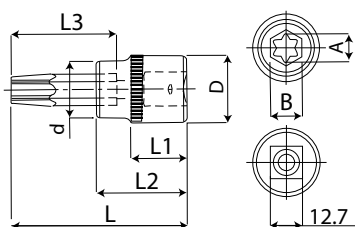

JOT41820 – JOT41870 S07H4320 -S07H4370		1/2" Dr. Torx Bit Sockets								
Item	Art. No	A (Size)	L3 (mm)	B (mm)	L (mm)	D (mm)	d (mm)	L1 (mm)	L2 (mm)	Wt (g)
JOT41820	S07H4320	T20	75	7.88	100	24	15	20	38	88
JOT41825	S07H4325	T25	75	7.88	100	24	15	20	38	90
JOT41827	S07H4327	T27	75	7.88	100	24	15	20	38	90
JOT41830	S07H4330	T30	75	7.88	100	24	15	20	38	90
JOT41840	S07H4340	T40	75	7.88	100	24	15	20	38	92
JOT41845	S07H4345	T45	75	7.88	100	24	15	20	38	92
JOT41850	S07H4350	T50	75	7.88	100	24	15	20	38	92
JOT41855	S07H4355	T55	75	10	100	24	17	20	38	112
JOT41860	S07H4360	T60	75	14	100	24	22	20	38	172
JOT41870	S07H4370	T70	75	14	100	24	22	20	38	178

Hand Tool Range

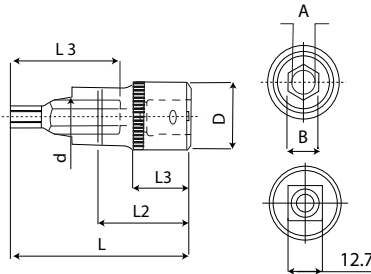

JOT4254 – JOT42519 S09H4304 – S09H4316			1/2" Dr. Hex Bit Sockets							
ItemNo		A (Size)	L3 (mm)	B (mm)	L (mm)	D (mm)	d (mm)	L1 (mm)	L2 (mm)	Wt (g)
JOT4254	S09H4304	H4	75	12	100	24	20.8	20	36	92
JOT4255	S09H4305	H5	75	12	100	24	20.8	20	36	92
JOT4256	S09H4306	H6	75	12	100	24	20.8	20	36	92
JOT4257	S09H4307	H7	75	12	100	24	20.8	20	36	92
JOT4258	S09H4308	H8	75	12	100	24	20.8	20	36	96
JOT42510	S09H4310	H10	75	12	100	24	20.8	20	36	116
JOT42512	S09H4312	H12	75	12	100	24	20.8	20	36	176
JOT42514	S09H4314	H14	75	12	100	24	20.8	20	36	180
JOT42516	S09H4316	H16	75	12	100	24	20.8	20	36	222
JOT42517	S09H4317	H17	75	12	100	24	20.8	20	36	243
JOT42519	S09H4319	H19	75	12	100	24	20.8	20	36	250

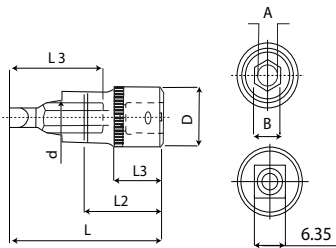

JOT4223 – JOT4227 S09H203 – S09H207			1/4" Dr. Hex bit Sockets							
Item	Art. No	A (Size)	L3 (mm)	B (mm)	L (mm)	D (mm)	D (mm)	L1 (mm)	L2 (mm)	Wt (g)
JOT4222	S09H202	H2	25	6.3	37	12	10.8	13	21	12
JOT42225	S09H225	H2.5	25	6.3	37	12	10.8	13	21	12
JOT4223	S09H203	H3	25	6.3	37	12	10.8	13	21	14
JOT4224	S09H204	H4	25	6.3	37	12	10.8	13	21	14
JOT4225	S09H205	H5	25	6.3	37	12	10.8	13	21	14
JOT4226	S09H206	H6	25	6.3	37	12	10.8	13	21	16
JOT4227	S09H207	H7	25	6.3	37	12	10.8	13	21	16

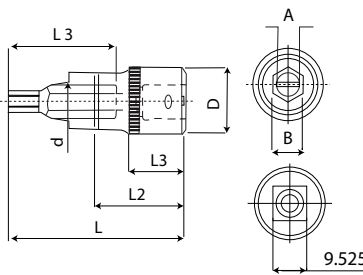

JOT4234 – JOT4239 S09H304 – S09H310			3/8" Dr. Hex Bit Sockets							
Item	Art. No	A (Size)	L3 (mm)	B (mm)	L (mm)	D (mm)	D (mm)	L1 (mm)	L2 (mm)	Wt (g)
JOT4234	S09H304	H4	30	6.3	48	18	13.8	15.5	26.5	36
JOT4235	S09H305	H5	30	6.3	48	18	13.8	15.5	26.5	38
JOT42355	S09H3055	H5.5	30	6.3	48	18	13.8	15.5	26.5	38
JOT4236	S09H306	H6	30	6.3	48	18	13.8	15.5	26.5	38
JOT4237	S09H307	H7	30	7.88	48	18	15.8	15.5	26.5	44
JOT4238	S09H308	H8	30	7.88	48	18	15.8	15.5	26.5	44
JOT4239	S09H310	H10	30	10	48	20	17.8	15.5	26.5	52

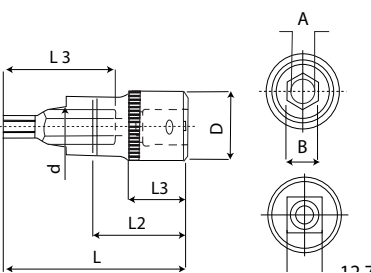

JOT4244 – JOT42419 S09H404 – S09H416			1/2" Dr. Hex Bit Sockets							
Item	Art. No	A (Size)	L3 (mm)	B (mm)	L (mm)	D (mm)	D (mm)	L1 (mm)	L2 (mm)	Wt (g)
JOT4244	S09H404	H4	30	10	55	22	17.8	20	36	72
JOT4245	S09H405	H5	30	10	55	22	17.8	20	36	72
JOT4246	S09H406	H6	30	10	55	22	17.8	20	36	74
JOT4247	S09H407	H7	30	10	55	22	17.8	20	36	74
JOT4248	S09H408	H8	30	10	55	22	17.8	20	36	76
JOT42410	S09H410	H10	30	10	55	22	17.8	20	36	86
JOT42412	S09H412	H12	30	12	55	24	20.8	20	36	118
JOT42414	S09H414	H14	30	12	55	24	20.8	20	36	122
JOT42416	S09H416	H16	30	12	55	24	20.8	20	36	132
JOT42417	S09H417	H17	30	12	55	24	20.8	20	36	136
JOT42419	S09H419	H19	30	12	55	24	20.8	20	36	142

SOCKETS - INDIVIDUALLY AVAILABLE

Hand Tool Range



SCREWDRIVERS

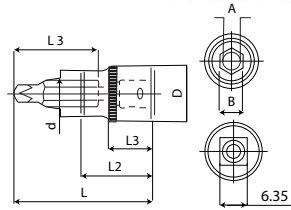
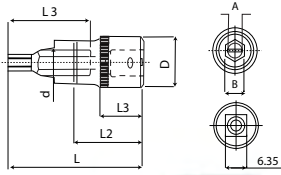

JOT401S1004 – S1055 S10H240 – S10H255		1/4" Dr. Slotted Bit Sockets								
Item	Art. No	A (Size)	L3 (mm)	B (mm)	L (mm)	D (mm)	d (mm)	L1 (mm)	L2 (mm)	Wt (g)
JOT401S1004	S10H240	4mm	25	6.3	37	12	10.8	13	21	14
JOT401S1007	S10H270	7mm	25	6.3	37	12	10.8	13	21	14
JOT401S1055	S10H255	5.5mm	25	6.3	37	12	10.8	13	21	14

JOT401S10PH1 - JOT401S10PH3 S11H201 - S11H203		1/4" Dr. Phillips Bit Sockets								
Item	Art. No	A (Size)	L3 (mm)	B (mm)	L (mm)	D (mm)	d (mm)	L1 (mm)	L2 (mm)	Wt (g)
JOT401S10PH1	S11H2#1	PH1	25	6.30	37	12	10.8	13	19	14
JOT401S10PH2	S11H2#2	PH2	25	6.30	37	12	10.8	13	19	14
JOT401S10PH3	S11H2#3	PH3	25	6.30	37	12	10.8	13	19	14



JOT500 D71PP08S	8 Pc Non Slip Grip Screwdriver Set
D71S	4 Pc Slotted Screwdrivers: 6.5x38mm; 4x80mm, 5.5x125mm; 6.5x150mm
D71P	4 Pc Phillips Screwdrivers: PH2x38mm; PH1x80mm; PH2x100mm; PH3x150mm

JOT501 D70PP10S	10 Pc Mechanic Go Thru Impact Screwdriver Set
CONTENTS	1-450mm Pick Up
D70P	(Star) 1.0 x 75, 2.0 x 100, 3.0 x 125, 2.0 x 38
D70S	(Flat) 5.5 x 100, 6.5 x 125, 8.0 x 150, 9.5 x 175, 6.5 x 38

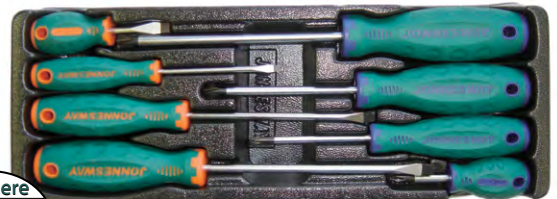

JOT514 D70105SP	5 Pc Go Through Impact Screwdriver set
D70S	3 Pc - Slotted Screwdriver: 6.5x125, 8x150, 9.5x175
D70P	2 Pc - Phillips Screwdrivers: #2x100, #3x150

JOT652 D71PP08SC	8 Pc Non Slip Grip Screwdriver Set
D04S	4 Pc Slotted Screwdrivers : 6.5x38,4x80,5.5x125,6.5x150
D04P	4 Pc Phillips Screwdrivers; #2x38, #1x80,#2x100,#3x150



JOT505 D3765P08S	8 Pc Precision Screwdriver set
Designed for Electronics and fine Engineering. Finger tip swivel top for better control and quick fastening.	
Chrome - Molybdenum Vanadium Steel Blade.	
Nylon - T.P.R. Non-Slip Handle.	
3 Pc Phillips: 00; 0.1	
5 Pc Slotted: 2; 2.4; 3; 3.5; 4 mm	

Hand Tool Range



JOT508 DR0253S		53 Pc Flexible Ratchet Screwdriver Bit Set	
1 Pc - Flexible Ratchet Screwdriver W/Magnetic Nut, Lock Function			
35 Pc - Bits, S2, 25mm: Phillips: PH#1, PH#2, PH#3 Slotted: 3, 4, 5.5, 7 mm Pozi: PZ#0, PZ#1, PZ#2, PZ#3 Star: T6, T8, T9, T10, T15, T20, T25, T27, T30, T40 Hex: 2, 2.5, 3, 4, 5, 6 mm Star (Tamperproof): T8, T10, T15, T20, T25, T27, T30, T40			
15 Pc - 1/4" Dr. Socket, 25mmL: 4, 5, 6, 7, 8, 9, 10, 11, 12, 13 mm 3/16", 1/4", 5/16", 3/8", 1/2"			
1Pc Bit Holder			
1Pc Magnetic Holder			



JOT515 D71T109S		9 Pc Anti-Slip Grip Torx Screwdriver Set				
Code	Art No	Size	Shank mm	Blade mm	Grip mm	L mm
JOT515c	D71T8	T8	3	60	72	132
JOT515d	D71T9	T9	3	60	72	132
JOT515e	D71T10	T10	4	80	90	170
JOT515f	D71T15	T15	4	80	90	170
JOT515a	D71T20	T20	5	100	110	210
JOT515g	D71T25	T25	5	100	110	210
JOT515h	D71T27	T27	6	100	119	244
JOT515b	D71T30	T30	7	125	119	244
JOT515i	D71T40	T40	8	150	129	279



JOT505P0 - JOT505S30 D3765T5 - D3765T20		Precision Screwdrivers, Phillips & Slotted	
Item	Art. No	Size	l (mm)
JOT505P0	D3765P0	0	50.65
JOT505P00	D3765P00	00	50.65
JOT505P1	D3765P1	1	50.65
JOT505S10	D3765S10	1.0	50.65
JOT505S16	D3765S16	1.6	50.65
JOT505S20	D3765S20	2.0	50.65
JOT505S24	D3765S24	2.4	50.65
JOT505S30	D3765S30	3.0	50.65



JOT010 T10148		Torque Screw Driver		
Drive	Capacity Nm/ FT-lbs	Diameter (mm)	l (mm)	Weight (kg)
1/4"	1-8 Nm	43	147	0.33
10 - 25L Bit Set PH - 0 x 2; 1 x 2; 2 x 2; 3 x 2 SLOTTED - 4, 6				
10 - 25L Tamper Bit Set TX - 10, 15, 20, 25, 30, 40 HEX - 3, 4, 5, 6				
1Pc Bit Holder for 6.35mm use.				



JOT506 DV13PP07S		7 Pc VDE Insulated 1000 volts Screwdriver set		
DV13S	3 Pc Phillips Screwdrivers: PH0x60, PH1x80, PH2x100			
DV13P	3 Pc Slotted Screwdrivers: 4x100, 5.5x125, 6.5x150			
DV13EP	1 Pc "GS" Tester Pen 220 - 250V			



JOT506060-JOT5066150 DV13P060 - DV13S6150		VDE Insulated 1000 volts Screwdriver			
Item	Art. No	Size	Blade (mm)	Grip (mm)	l (mm)
JOT506060	DV13P060	PH0	60	98	158
JOT506180	DV13P180	PH1	80	104	184
JOT5062100	DV13Z2100	PZ1	80	104	184
JOT5064100	DV13S4100	4.0	100	98	198
JOT5065125	DV13S5125	5.5	125	104	229
JOT5066150	DV13S6150	6.5	150	110	260



JOT507T5 - JOT507T20 D3765T5 - D3765T20		Precision Torx Screwdrivers	
Item	Art. No	Size	l (mm)
JOT507T5	D3765T5	T5	50.65
JOT507T6	D3765T6	T6	50.65
JOT507T7	D3765T7	T7	50.65
JOT507T8	D3765T8	T8	50.65
JOT507T9	D3765T9	T9	50.65
JOT507T10	D3765T10	T10	50.65
JOT507T15	D3765T15	T15	50.65
JOT507T20	D3765T20	T20	50.65



Hand Tool Range SCREWDRIVERS - INDIVIDUALLY AVAILABLE



JOT5001 - JOT50025 D71P060 - D71S9175			Full Star Screwdrivers			
Item	Art. No	Size	Diameter	Blade	Grip	Total Length
JOT5001	D71P060	PH0	3mm	60mm	90mm	150mm
JOT5002	D71P138	PH1	5mm	38mm	56mm	94mm
JOT5003	D71P175	PH1	5mm	75mm	110mm	185mm
JOT5004	D71P180	PH1	5mm	80mm	110mm	190mm
JOT5005	D71P1150	PH1	5mm	150mm	110mm	250mm
JOT5006	D71P238	PH2	6mm	38mm	56mm	94mm
JOT5007	D71P2100	PH2	6mm	100mm	119mm	219mm
JOT5008	D71P2150	PH2	6mm	150mm	119mm	269mm
JOT5009	D71P3125	PH3	8mm	125mm	129mm	254mm
JOT50010	D71P3150	PH3	8mm	150mm	129mm	279mm
JOT50011	D71P4200	PH4	10mm	200mm	129mm	329mm
JOT50012	D71S250	2.4	2.4mm	50mm	72mm	122mm
JOT50013	D71S360	3	3mm	60mm	72mm	132mm
JOT50014	D71S480	4	4mm	80mm	90mm	170mm
JOT50015	D71S538	5.5	5mm	38mm	56mm	94mm
JOT50016	D71S575	5.5	5mm	75mm	110mm	185mm
JOT50017	D71S5125	5.5	5mm	125mm	110mm	235mm
JOT50018	D71S5200	5.5	5mm	200mm	110mm	310mm
JOT50019	D71S638	6.5	6mm	38mm	56mm	94mm
JOT50020	D71S6100	6.5	6mm	100mm	119mm	219mm
JOT50021	D71S6150	6.5	6mm	150mm	119mm	269mm
JOT50022	D71S8150	8	7mm	150mm	129mm	279mm
JOT50023	D71S8175	8	7mm	175mm	129mm	304mm
JOT50024	D71S8200	8	7mm	200mm	129mm	329mm
JOT50025	D71S9175	9.5	8mm	175mm	129mm	304mm
JOT50026	D71S5150	5.5	5mm	150mm	110mm	260mm

JOT504175 – JOT50433125 D70P175 – D70Z3125			Go-Thru Impact Screwdrivers		
Item	Art. No	Size	Blade	Grip	Weight
JOT504175	D70P175	PH1x75	75mm	182mm	95g
JOT5042100	D70P2100	PH2x100	100mm	227mm	152g
JOT5043125	D70P3125	PH3x125	125mm	269mm	268g
JOT5043150	D70P3150	PH3 x 150	150mm	294mm	250g
JOT5045100	D70S5100	SL5.5x100	100mm	207mm	99g
JOT5046125	D70S6125	SL6.5x125	125mm	252mm	159g
JOT5048150	D70S8150	SL8x150	150mm	294mm	250g
JOT5049175	D70S9175	SL9.5x175	175mm	319mm	293g

JOT5021 – JOT5024 D71Z138 - D71Z3125			Full Star Pozi Screwdrivers			
Item	Art. No	Size	Diameter	Blade	Grip	Total Length
JOT5021	D71Z180	PZ.1	5mm	80mm	110mm	190mm
JOT5022	D04Z238	PZ.2	6mm	38mm	56mm	94mm
JOT50221	D71Z2100	PZ.2	6mm	100mm	119mm	219mm
JOT5023	D71Z3125	PZ.3	8mm	125mm	129mm	254mm
JOT5041175	D70Z175	PZ1x75	-	75mm	182mm	95g
JOT50422100	D70Z2100	PZ2x100	-	100mm	227mm	152g
JOT50433125	D70Z3125	PZ3x125	-	125mm	269mm	268g

JOT504238 – JOT5046538 D70P238 – D70S6538			Stubby Screwdrivers		
Item	Art. No	Size	Blade (mm)	Grip (mm)	Weight (g)
JOT504238	D70P238	PH2 x 38	38	57	40
JOT5046538	D70S6538	6.5 x 38mm	38	56	40



JOT607 - TOOL CHEST SET 62 PC
C-3DH362



Contents

D70

6 Pc Go-Thru Screwdriver Set PH#1x75, PH#2x100, PH#3x125
5.5x100, 6.5x125, 8.0x150



P087 - 1 Pc 7" Combination Pliers

P106 - 1 Pc 6" Diagonal Cutting Nippers
P116 - 1 Pc 6" Long Nose Pliers



W26

18 Pc Combination Wrench Set 6-22,24mm

H06SM109S

9 Pc Long Arm Hex Key Set 1.5,2,2.5,3,4,5,6,8,10mm



S21H4150 - 1 Pc 1/2" Dr. Wobble Extension Bar 3"

S24H4 - 2 Pc 1/2" Dr. Extension Bar: 125, 250mm

S23H41300 - 1 Pc 1/2" Dr. Sliding Bar 300mm

S22H41450 - 1 Pc 1/2" Dr. Flexible Handle 450mm

S17H4121 - 1 Pc 1/2" Dr. Spark Plug 21mm



S04H4 - 18 Pc 1/2" Dr. Socket Set 10-32mm

R2904 - 1 Pc 1/2" Dr. Anti-Slip Ratchet Handle

S15H472 - 1 Pc 1/2" Dr. Universal Joint

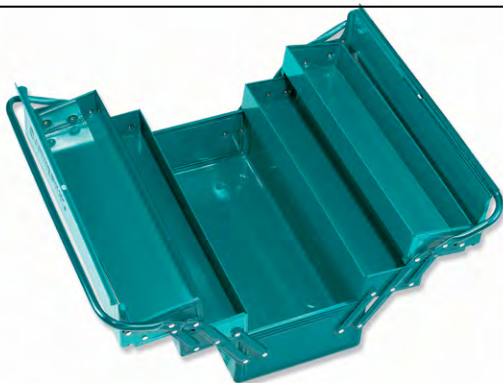

JOT604
C3DH2

3 Section Portable Tool Chest

Size : 470mm x 220mm x 350mm

TOOL CHEST SETS

Hand Tool Range



JOT613 - 253 PC BLACK EDITION TOOL TROLLEY

C7D1239V

BLACK EDITION

Tool Trolley



BLACK EDITION

TROLLEY FEATURES:

- Steel thickness: Cabinet - 1.0mm Drawer, 1.2 mm Body, 1.2mm top and bottom covers
- Ball bearing design for smooth drawer sliding.
- Scratch resistant, safe-design aluminium end
- Internal locking system for extra security
- 90.72kg loading capacity per Caster.
- Knockable working table
- 5" x 2" Casters
- Durable foam inserts inside drawers keeping tools secure and organised.
- Satin black finish

Contents



Drawer 1
111 Pc 1/4" & 1/2" Dr. Socket Set



Drawer 2
67 Pc 3/8" Dr. Socket & Mechanic Set



Drawer 3
25 Pc Go-Through Screwdriver, Hacksaw And Punch Set

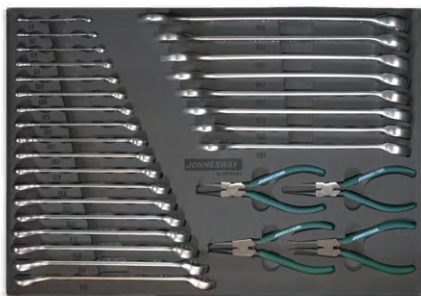

Drawer 4
26 Pc German Type Combination Wrench Set, 4 Pc Internal & External Pliers Set



Drawer 5
19 Pc Two Way Hex Key Set & Pliers

Hand Tool Range



Detailed Composition

BLACK EDITION

Hand Tool Range

First Drawer

111Pcs 1/4" & 1/2" Dr. Socket Set (S04H45111SV)

- 34Pcs 1/4" Dr. Socket & Socket Bit Set
- 12Pcs Socket:4,5,5.5,6,7,8,9,10,11,12,13,14mm (S04H2)
- 10Pcs Deep Socket:4,5,6,7,8,9,10,11,12,13mm (S04HD2)
- 2Pcs Extension Bar: 2", 6"(S24H250 & S24H2150)
- 1Pc Spinder Handle(S26H2150)
- 1Pc Universal Joint (S15H240)
- 1Pc 48Teeth Lever Type Ratchet Handle (R3702)
- 4Pcs Star Bit Socket: T6,T7,T8,T9 (S07H2)
- 3Pcs Hex Bit Socket: H3,H4,H5 (S09h2)
- 44Pcs 1/2" Dr. Socket & Socket Bit Set
- 20Pcs Socket: 10,11,12,13,14,15,16,17,18,19,20,21, 22,23,24,27,30,32,34,36mm (S04H4)
- 10Pcs Deep Socket:10,11,13,14,15,17,19,21,22, 24mm (S04hd4)
- 2Pcs Extension Bar: 2", 6" (S24H4125 & S24H4250)
- 1Pc Sliding T Bar 300mm (S23H41300)
- 1Pc Universal Joint (S15h472)
- 1Pc Flexible Handle 450mm (S22h41450)
- 1Pc 48Teeth Lever Type Ratchet Handle (R3704)
- 5Pcs Hex Bit Socket: H12,H14,H16,H17,H19 (S09h4)
- 3Pcs Star Bit Socket: T55,T60,T70(S07h4)
- Adapter, Size: 1/2"(F),3/4"(M) (S16h1234)
- 1/4" Dr. Universal Spinner Handle, 280mm (S26H2280)
- 31Pcs Screwdriver Bit Set (DBT31B)

Second Drawer

67Pcs 3/8" Dr. Socket & Mechanic Set (S04H3567SV)

- 42Pcs 3/8" Dr. Socket & Socket Bit Set (S04H3156S)
- 17Pcs Socket:6,7,8,9,10,11,12,13,14,15,16,17,18,19, 20,21,22mm (S04H3)
- 18Pcs Deep Socket:6,7,8,9,10,11,12,13,14,15,16,17, 18,19,20,21,22,24mm (S04HD3)
- 2Pcs Extension Bar: 3", 6"(S24H375 & S24H3150)
- 1Pc Sliding T Bar 300mm (S23H31200)
- 1Pc Universal Joint (S15H356)
- 2Pcs Spark Plug 16, 21mm (S17H31)
- 1Pc 48Teeth Lever Type Ratchet Handle (R3703)
- 9Pcs Star Bit Socket:t10,T15,T20,T25,T27,T30,T40, 45,T50 (S07h3)
- 5Pcs Hex Bit Socket: H5.5, H6, H7, H8, H10 (S09h3)
- 3Pcs Adaptor: Size: 1/4"(F),3/8"(M) - S16H1438
Size: 3/8"(F),1/2"(M) - S16H3812
Size: 1/4"(M) X 3/8"(F) - S16H302
- Measuring Tapes,Size: 5M/16Ftx3/4"(19mm) (MT0302)
- 10" Machined Tongue & Groove Groove Water Pump Plier (P2710)
- 10" Curved Jaw Locking Plier With Wire Cutter (P32M10A)
- Magnetic Pick-Up Tool (AG010034)
- Stainless Steel Ruler, Size: 12"/300mm (MTC156)
- 2Pcs "O"Ring And Hook Scribe Set (AI030025)
- Telescoping Inspection Mirror, Size: 50 X 92mm (AG010033)
- 12" Pipe Wrench (W2812)

Third Drawer

25Pcs Go-Through Screwdriver, Hacksaw and Punch Set (D737125SV)

- 10Pcs Mechanic Go Thru Impact Screwdriver Set (D70PP10S)
- 4Pcs -Phillips: 1.0X75,2.0x100,3.0x125,2.0x38
- 5Pcs -Slotted: 5.5X100,6.5x125,8.0x150,9.5x175, 6.5x38
- 1Pc - 450mm Pick Up
- 13Pcs Hacksaw, Chisel, Punch Set (M645113S)
- 6Pcs Pin Punch Set, Black Finish: 2X8x115mm, 3X8x125mm, 4X9.5x150mm, 5X9.5x165mm, 6X12.7x180mm, 8X12.7x180mm
- 4Pcs Chisel Punch Set/Black Finish
Taper Punch 3X9.5x120mm,
Center Punch 2X9.5x120mm,
Cold Chisel 12X9.5x130mm,
Cape Chisel 5X9.5x130mm
- 3Pcs Hacksaw Set: 1Pc Heavy Duty Deluxe Type Hacksaw (With 2Pc Spare Saw Blade)
- 10" Tiger's Paw Adjustable Wrench W/Tpr Handle (W27AT10)
- Quick Change Blade Retractable Utility Knife (MK2040)

Fourth Drawer

30Pcs Professional Wrench Set & Pliers (W26530SV)

- 26Pcs German Type Combination Wrench Set (W26126S)
- 4Pcs Internal & External Pliers Set (AG010002SV)

Fifth Drawer

19Pcs Two Way Hex Key Set & Pliers (H10119SV)

- 8" Side Cutting Pliers & 8" Diagonal Pliers & 8" Long Nose Pliers (P018SV)
- 8Pcs Two Way Ball Point & Hex Key Set (H10MB08SV)
- 8Pcs Two Way Star & Tamperproof Key Set (H10MT08SV)

JOT615 (C-7DW1)

7 Drawer Black Edition Tool Trolley, sold seperately with no tools included



JOT612 - 62 PC BLACK EDITION TOOL CHEST SET

C-3DH262V

BLACK EDITION

BLACK EDITION *Tool Chest*



Contents

- 18 Pc ½" Dr. Socket Set 10-32mm
- 18 Pc Combination Wrench Set 6-22,24mm
- 9 Pc Long Arm Hex Key Set 1.5,2,2.5,3,4,5,6,8,10mm
- 6 Pc Go-Thru Screwdriver Set PH#1x75, PH#2x100, PH#3x125
- 5.5x100, 6.5x125, 8.0x150
- 7" Combination Pliers
- 6" Diagonal Cutting Nippers
- 6" Long Nose Pliers
- ½" Dr. Anti-Slip Ratchet Handle
- ½" Dr. Extension Bar: 125, 250mm
- ½" Dr. Sliding Bar 300mm
- ½" Dr. Flexible Handle 450mm
- ½" Dr. Universal Joint
- ½" Dr. Wobble Extension Bar 3"
- ½" Dr. Spark Plug 21mm

SPECIAL FEATURES:

- **Durable foam inserts inside division keeping tools secure and organised.**
- **Satin black finish.**

Hand Tool Range



JOT614 - 196 PC BLACK EDITION 6 DRAWER TOOL TOP CHEST SET

C-6DA6196V

BLACK EDITION



Suggested ADD-IT-ON



BLACK EDITION

Tool Chest

Features:

- Designed in conjunction with the Imperial Technical Training Academy.
- Ideal selection for a young starting professional.
- Satin black finish.
- Durable foam inserts inside divisions keeping tools secure and organised.

The Black Edition Top Chest is a perfect fit with the Black Edition Tool Trolley. (JOT613 on page 78 OR JOT615 on page 79.)

Contents



Drawer 1
23Pc Pliers, Keys and Punch Set



Drawer 2
27Pcs Screwdriver and Ratcheting Combination Wrench Set



Drawer 3
61Pc 1/4" & 3/8" Dr. Socket and Mechanical Set

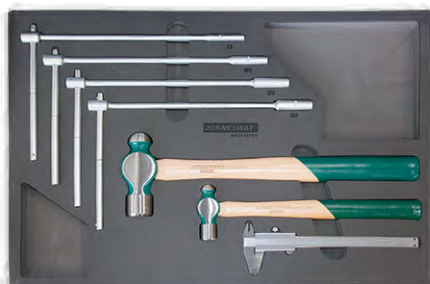

Drawer 4
7Pc Hammer and Sliding T-handle Socket Set



Drawer 5
50 Pcs 1/2" Dr. Socket and Flare Nut Wrench Set.



Drawer 6
26Pc German Type Combination Wrench Set, Sizes 6 - 32mm

Hand Tool Range



JOT610 - TOOL CHEST SET 92 PC
C-3DH292



Contents

TOOL TROLLEY & CHESTS



S04H4120ST

18 Pc 1/2" Dr. Socket & 1 Pc 1/2" Dr. Universal Joint
1/2" Dr. Socket (S04h4) Size :
10,11,12,13,14,15,16,17,18,19,20,21,22,23,24,27,30,32mm
1/2" Dr. Universal Joint (S15h472)



W26902ST

11 Pc Combination Wrench Set (mm) And Hex Key Set
6, 7, 8, 9, 10, 11, 12, 13, 14, 15, 16mm
9 Pc Extra Long Arm Hex Key (H03sm109s)
Size: 1.5,2,2.5,3,4,5,6,8,10mm



W26107ST

7 Pc Combination Wrench Set (mm)
17, 18, 19, 20, 21, 22, 24 mm



S04H5222ST

18 Pc 1/4" Dr. Socket Set + W/4 Pc Screwdriver Set
4 Pc Anti-Slip Screwdriver(D71):Ph#2X38, Ph#2X100, 6.5X100, 6.5X38mm
12 Pc 1/4" Dr. 6Pt Sockets(S04h2): 4,4.5,5,5.5,6,7,8,9,10, 11,12,13
1 Pc 1/4" Dr. Quick Release Reversible Ratchet Handle(R2902)
1 Pc 1/4" Dr. Extension Bar, L: 50mm (S24H250)
1 Pc 1/4" Dr. Extension Bar, L: 100mm(S24H2100)
1 Pc 1/4" Dr. Flexible Handle, L: 130mm (S22H21130)
1 Pc 1/4" Dr. Sliding T-Bar, L:110mm (S23H21130)
1 Pc 1/4" Dr. Universal Joint (S15H240)



S04H4506ST

Extension Bar And Flexible Handle For C-3Dh262
2 Pc 1/2" Dr. Extension Bar: 125, 250mm (S24h4)
1 Pc 1/2" Dr. Sliding Bar 300mm (S23h41300)
1 Pc 1/2" Dr. Flexible Handle 450mm,Knurl Type (S22h41450)
1 Pc 1/2" Dr. Wobble Extension Bar (21H4150)
1 Pc 1/2" Dr. Spark Plug 21mm (S17h4121)



S04H3116ST

16 Pc 3/8" Socket Set
6 Pc 3/8" Dr Star Socket (S06h3), E10,E11,E12,E14,E16,E18
5 Pc 3/8" Dr Star Bitsocket (S07h3), T25,T30,T40,T45,T50
1 Pc 3/8" Dr. Spark Plug Socket, Size:5/8" (S17h3216)
1 Pc 3/8" Dr. Extension Bar, L: 75mm(S24h375)
1 Pc 3/8" Dr. Extension Bar (S24h3150): Size:3/8", L: 150mm
1 Pc 3/8" Dr. Universal Joint (S15h356)
1 Pc 3/8" Dr. Adaptor, Size: 1/2" (S16h1238)

Hand Tool Range

Tool Kit



JOT404 S04H62477S		77 Pc 1/2" & 1/4" Dr. Tool Kit	
CONTENTS			
8 Pc Combination Wrench:			
	JOT31408	W26108	8mm
	JOT31410	W26110	10mm
	JOT31412	W26112	12mm
	JOT31413	W26113	13mm
	JOT31414	W26114	14mm
	JOT31415	W26115	15mm
	JOT31417	W26117	17mm
	JOT31419	W26119	19mm
1Pc Combination Plier	JOT404088	P088	8"
1Pc Waterpump Plier	JOT4042810	P2810	250mm
5 Pc Full Star Anti-Slip Grip Screwdrivers			
	JOT5004	D71P180	PH1X80mm(+)
	JOT5007	D71P2100	PH2X100mm(+)
	JOT50010	D71P3150	PH3X150mm(+)
	JOT50014	D71S480	0.8X4X80(-)
	JOT50020	D71S6100	1.2X6.5X100mm(-)
13 Pc 1/2" Dr. Flank Sockets 6Pt			
	JOT41312	S04H4112	12mm
	JOT41313	S04H4113	13mm
	JOT41314	S04H4114	14mm
	JOT41315	S04H4115	15mm
	JOT41317	S04H4117	17mm
	JOT41318	S04H4118	18mm
	JOT41319	S04H4119	19mm
	JOT41321	S04H4121	21mm
	JOT41322	S04H4122	22mm
	JOT41324	S04H4124	24mm
	JOT41327	S04H4127	27mm
	JOT41330	S04H4130	30mm
	JOT41332	S04H4132	32mm

continued...

1 Pc 1/2" Dr. 36 Teeth Quick Release Ratchet Handle	JOT201	R2904	
1 Pc 1/4" Dr. 36 Teeth Quick Release Ratchet Handle	JOT200	R2902	
2 Pc 1/2" Dr. Extension Bars			
	JOT454250	S24H4250	250mm
	JOT454125	S24H4125	150mm
1 Pc 3/8" (F) x 1/2" (M) Adapter for Extension	JOT451b	S16H304	
2 Pc 1/2" Dr. Spark Plug Socket			
	JOT42716	S17H4116	16mm
	JOT42721	S17H4121	21mm
2 Pc Universal Joints			
	JOT4403	S15H240	1/4"
	JOT4401	S15H472	1/2"
1 Pc 1/4" Dr. Sliding "T" Handle	JOT400S23H	S23H21130	
5Pc Hex Key Set: 1.5,2,3mm	JOT40401M03S	H01M03S	
1 Pc 1/4" Dr. Extension Bar 75mm (3")	JOT4503	S24H275	
4 Pc 1/4" Dr. Deep Sockets:			
	JOT4108	S04HD2108	8mm
	JOT41010	S04HD2110	10mm
	JOT41012	S04HD2112	12mm
	JOT41013	S04HD2113	13mm
9 Pc 1/4" Dr. Sockets			
	JOT4094	S04H2104	4mm
	JOT4095	S04H2105	5mm
	JOT4096	S04H2106	6mm
	JOT4097	S04H2107	7mm
	JOT4098	S04H2108	8mm
	JOT4099	S04H2109	9mm
	JOT40910	S04H2110	10mm
	JOT40911	S04H2111	11mm
	JOT40912	S04H2112	12mm
1 Pc 1/4" Dr. Flexible Extension	JOT454145	S27H2	
1 Pc 1/4" Dr. Spinner Handle	JOT404S26H2	S26H2150	
1 Pc 1/4" Dr. Coupler/Bit Holder	JOT404S44H2	S44H2206	
1 Pc Hammer Hickory Handle 500g GS Approved	JOT807500	M09500	
18 Pc 1/4" Dr. Bits:			
	JOT404130F3	D130F3	Slotted 3mm
	JOT404130F4	D130F4	Slotted 4mm
	JOT404130F5	D130F5	Slotted 5mm
	JOT404130F6	D130F6	Slotted 6mm
	JOT404130TX10	D130TX10	Torx T10
	JOT404130TX15	D130TX15	Torx T15
	JOT404130TX20	D130TX20	Torx T20
	JOT404130TX25	D130TX25	Torx T25
	JOT404130TX27	D130TX27	Torx T27
	JOT404130TX30	D130TX30	Torx T30
	JOT404130TX40	D130TX40	Torx T40
	JOT404130P1	D130P1	Phillips PH#1
	JOT404130P2	D130P2	Phillips PH#1
	JOT404130P3	D130P3	Phillips PH#1
	JOT404130H3	D130H3	Hex 3mm
	JOT404130H4	D130H4	Hex 4mm
	JOT404130H5	D130H5	Hex 5mm
	JOT404130H6	D130H6	Hex 6mm
(18Pc 1/4" Dr. Bits also sold as a set - JOT404bs / S04H5-B18S)			



JOT603



JOT602



JOT601

JOT602 C6DA4		6 Drawer medium Tool Top Chest				
	W		D		H	
Overall	26"	660mm	12"	305mm	15"	380mm
3 Drawer	6.7"	172mm	10.5"	270mm	1.6"	41mm
2 Drawer	22.5"	572mm	10.5"	270mm	1.6"	41mm
1 Drawer	22.5"	572mm	10.5"	270mm	2.5"	65mm
	NW 23 kg		GW 26.9 kg		CUFT 3.97'	
Steel thickness: Top Chest: 1.0mm drawer, 1.0mm body, 1.0mm drop-font.						
100% open ball bearing slide on small and full-width drawer.						
Easy move ball bearing drawer slides on all drawers for professional use.						
Drawer dentent (stopper) to prevent unintentional opening of drawer for Replacement						

JOT603 C6DA6		6 Drawer Large Tool Top Chest				
	W		D		H	
Overall	26"	660mm	18"	455mm	19"	484mm
5 Drawers	22.8"	579mm	15"	380mm	1.83"	46.6mm
1 Drawer	22.8"	579mm	15"	380mm	2.2"	56mm
	NW 46.5 kg		GW 52.5 kg		CUFT 8.5'	
Ball Bearing Slides.						
Steel thickness : 1.0mm						
Top Chest, 1.0mm body.						

JOT601 C-7DW1		7 Drawer Tool Trolley (Tools not included)		
	W	D	H	
Overall	26.3"	18"	32"	Inch
	670	460	813	mm
Overall (with Casters)	26.3"	18"	37"	Inch
	670	460	943	mm
5 Drawers	22.8"	15"	2.2"	Inch
	579	380	56	mm
2 Drawers	22.8"	15"	4.8"	Inch
	579	380	123	mm
	N.W	G.W	CUFT	
	74.5 kg	82.5 kg	12.32"	

- Steel thickness: Cabinet - 1.0mm Drawer, 1.2 mm Body, 1.2mm top and bottom covers
- Ball bearing design for smooth drawer sliding.
- Knock able working table
- Scratch resistant, safe-design aluminium end
- Internal locking system for extra security
- 5" x 2" Casters
- 90.72 kg loading capacity per Caster.



JOT71714 – JOT71730 P4314-P4330			Bolt and Cable Cutter				
Code	Item No	l (inch)	Bolt		Wire	Cable	Weight (kg)
			Soft Metals	Medium Metals			
JOT71714	P4314	14"	7(1/4")	5(3/16")	3.2(1/8")	8(5/16")	1.015
JOT71718	P4318	18"	8(5/16")	6(1/4")	5(3/16")	10(3/8")	1.57
JOT71724	P4324	24"	10(3/8")	8(5/16")	7(9/32")	12(15/32")	2.68
JOT71730	P4330	30"	13(1/2")	8(5/16")	9(3/8")	14(9/16")	4.2



JOT733 & JOT734 P0817 - P0818			Combination Pliers	
Code	Item No	l (inch)	l (mm)	Weight (g)
JOT733	P0817	7"	180 mm	310
JOT734	P0818	8"	200mm	410



JOT738 - JOT659068 P066 - P068			Multi Purpose Long Nose Pliers	
Code	Item No	l (inch)	l (mm)	Weight (g)
JOT738	P066	6"	167mm	130
JOT659068	P068	8"	200mm	180



JOT694 & JOT696 P1016 - P1017			Diagonal Cutting Nippers	
Code	Item No	l (inch)	l (mm)	Weight (g)
JOT694	P1016	6"	160mm	240
JOT696	P1017	7"	180mm	270



JOT723 P079		9" Multipurpose Side Cutting Pliers	
l (Inch)	l (mm)	Weight (g)	
9"	220	410	



JOT695 & JOT697 P1116 & P1118			Long Nose Pliers	
Code	Item No	l (inch)	l (mm)	Weight (g)
JOT695	P1116	6"	160mm	180
JOT697	P1118	8"	200mm	260



JOT659018 P018		8" Combination Side Cutting Pliers	
l (inch)	l (mm)	Weight (g)	
8"	212	342	



JOT737 P046		6" Diagonal Cutting Pliers	
l (Inch)	l (mm)	Weight (g)	
6"	160	155	



JOT700 & JOT404088 P087 - P088			Combination Pliers	
Code	Item No	l (inch)	l (mm)	Weight (g)
JOT700	P087	7"	180 mm	310
JOT404088	P088	8"	200mm	410



JOT708 P4008		8" Welding Pliers	
l (Inch)	l (mm)	Weight (g)	
8 - 1/2"	214	280	



JOT659038 P038		8" Diagonal Side Cutters	
l (inch)	l (mm)	Weight (g)	
8"	197	270	



JOT72808 P8008		8" Combination Pliers with TPR Handles	
Type:	l (inch)	l (mm)	Weight (g)
Spring loaded	8	200	375



JOT73008 P8708		8" Diagonal Cutting Pliers with TPR Handles	
Type:	l (inch)	l (mm)	Weight (g)
Spring loaded	8	200	345



JOT72908 P8108		8" Long Nose Pliers with TPR Handles	
Type:	l (inch)	l (mm)	Weight (g)
Spring loaded	8	200	260



JOT709 P256		Easy Shift Internal-External Snap Ring Pliers	
l (Inch)	l (mm)	Weight (g)	
6"	150	170	



JOT73207 P7702		7" Compound Action Diagonal Cutting Pliers	
Inch	Metric (mm)	Weight (g)	
7"	180	220	



JOT658 P018SC		3 Pc Professional Pliers Set	
P018	1 Pc 8" Side Cutting Plier		
P038	1 Pc 8" Diagonal Cutter		
P068A	1 Pc 8" Long Nose Plier		



JOT651 AG010002SP		4 Pc Internal & External Pliers Set	
AG010002	1 Pc 7" (175mm) Straight Nose, Internal Plier		
AG010005	1 Pc 7" (175mm) Bent Nose, Internal Plier		
AG010008	1 Pc 7" (175mm) Straight Nose, External Plier		
AG010011	1 Pc 7" (175mm) Bent Nose, External Plier		

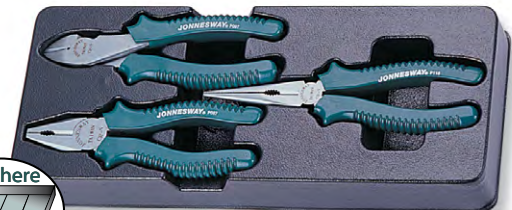

JOT660 P0803SC		3 Pc Pliers Set	
P087	7" Combination Plier		
P097	7" Heavy Duty Diagonal Cutting Plier		
P118	8" Long Nose Plier		



JOT661 P2710SC		Pliers Set	
P2710	1 Pc - 10" Machined Tongue & Groove Water Pump Plier		
P32M10A	1 Pc - 10" Curved Jaws Locking Pliers with Wire Cutter		

PLIERS / CUTTERS / CLAMPS

Hand Tool Range

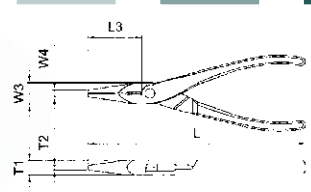
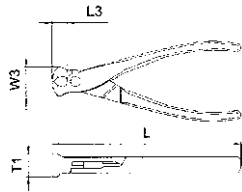

JOT711 P7102		Miniature End Cutting Nippers				
L	L3	W3	T1	Weight (g)	Cutting Wire Ømm	Tensile Strength (MPA)
110	8.1	16.6	13.2	90	1.25	1241

- Ergonomic design for comfortable grip.
- Spring Loaded.
- Lay on Joint.
- Meeting Standard Cutting & Loading Test.
- Chrome nickel Steel Drop Forged for Hardened Cutting Edge

JOT714 P7105		Miniature Long Nose Pliers					
L	L3	W3	W4	T1	Weight (g)	Cutting Wire Ø mm	Tensile Strength (MPA)
135	32.5	12.6	3.2	8.2	90	1.25	1241

- Ergonomic design for comfortable grip.
- Spring Loaded.
- Lay on Joint.
- Meeting Standard Cutting & Loading Test.
- Chrome nickel Steel Drop Forged for Hardened Cutting Edge.

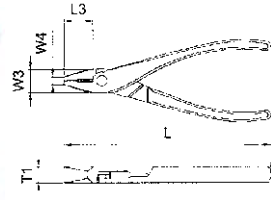
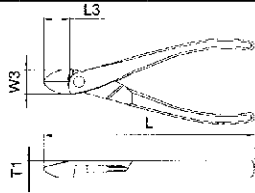

JOT712 P7103		Miniature Diagonal Pliers				
L	L3	W3	T1	Weight (g)	Cutting Wire Ømm	Tensile Strength (MPA)
115	13.5	13	8.2	90	1.25	1241

- Ergonomic design for comfortable grip.
- Spring Loaded.
- Lay on Joint.
- Meeting Standard Cutting & Loading Test.
- Chrome nickel Steel Drop Forged for Hardened Cutting Edge

JOT713 P7104		Miniature Lineman's Pliers					
L	L3	W3	W4	T1	Weight (g)	Cutting Wire Ø mm	Tensile Strength (MPA)
120	15.8	13.6	4	8.2	90	1.25	1241

- Ergonomic design for comfortable grip.
- Spring Loaded.
- Lay on Joint.
- Meeting Standard Cutting & Loading Test.
- Chrome nickel Steel Drop Forged for Hardened Cutting Edge
- Serrated Jaws.

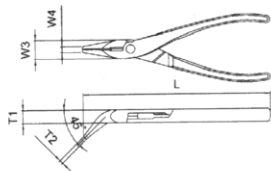

JOT710 P7101		Miniature Needle Nose Pliers				
L	W3	W4	T1	T2	Weight (g)	
140	12.6	3.2	8.2	2.4	90	

- Ergonomic design for comfortable grip.
- Spring Loaded.
- Lay on Joint.
- Bent Angle 45°.
- Chrome nickel Steel Drop Forged.

JOT7161 P2010LA		Aviation Tin Snips - Left	
I (inch)	I (mm)	Weight (g)	
10"	250	395	

- Drop forged CR-MO steel blades.
- Hardened serrated edges of HRC55-60.
- Hardened serrated edges of HRC60-62.
- Cutting capacity up to 1.2mm cold rolled steel or 0.7mm stainless steel.



JOT7162 P2010SA		Aviation Tin Snips - Straight		
I (inch)	I (mm)	Weight (g)		
10"	250	395		

- Drop forged CR-MO steel blades.
- Hardened serrated edges of HRC55-60.
- Hardened serrated edges of HRC60-62.
- Cutting capacity up to 1.2mm cold rolled steel or 0.7mm stainless steel.

JOT7163 P2010RA		Aviation Tin Snips - Right		
I (inch)	I (mm)	Weight (g)		
10"	250	395		

- Drop forged CR-MO steel blades.
- Hardened serrated edges of HRC55-60.
- Hardened serrated edges of HRC60-62.
- Cutting capacity up to 1.2mm cold rolled steel or 0.7mm stainless steel.



JOT4042810 P2810		Water Pump Pliers 10"	
l (inch)	l (mm)	Weight (g)	
10"	250	430	



JOT7088 – JOT70816 P2708 – P2712		Tongue in Groove Water Pump Pliers		
Code	Item	l (inch)	l (mm)	Weight (g)
JOT7088	P2708	8"	200	340
JOT70810	P2710	10"	250	400
JOT70812	P2712	12"	305	750
JOT70816	P2716	16"	406	1120



JOT724 P6118		8" End Cutters	
l (inch)	l (mm)	Weight (g)	
8"	200	380	



JOT720 P028		8" Wire Cutters	
l (inch)	l (mm)	Max Capacity Dia.(mm)	Weight (g)
8"	202	Ø 4.0	275



JOT73111 P7601		11" Long Pliers	
Angle	Inch	Metric (mm)	Weight (g)
0°	11"	275	330



JOT718 P7716		Wire Twisting Pliers	
JOT718	P7716	6"	



JOT740 P7801		Self Locking Multi-grip Pliers - Wide Flat Jaws	
Size (mm)	Jaw Adjustment (mm)	Weight (g)	
200	0-15	560	



JOT741 P7802		Self Locking Multi-grip Pliers - Double Curved Jaws	
Size (mm)	Jaw Adjustment (mm)	Weight (g)	
230	0-15	560	



JOT742 P7803		Self Locking Multi-grip Pliers - Wide Curved Jaws	
Size (mm)	Jaw Adjustment (mm)	Weight (g)	
210	0-10	515	



JOT743 P7804		Self Locking Multi-grip Pliers - Angled Jaws	
Size (mm)	Jaw Adjustment (mm)	Weight (g)	
210	0-15	480	



JOT744 P7805		Self Locking Multi-grip Pliers - Straight Jaws	
Size (mm)	Jaw Adjustment (mm)	Weight (g)	
195	0-18	460	



JOT72507 – JOT72510 P32M07C – P32M10C		Curved Jaw Locking Pliers with TPR Handle	
Item Code	Part No.	Size (inch)	Weight (g)
JOT72507	P32M07C	7"	330
JOT72510	P32M10C	10"	560



JOT702 P32M10A		Curved Jaw Locking Pliers 10"	
Size (inch)	10"	Weight (g)	560
Chrome Vanadium Jaw, Chrome Molybdenum Handle and Nickle Plated			



JOT72610 P30M10C		Straight Jaw Locking Pliers with TPR Handle 10"	
Item Code	Part No.	Size (inch)	Weight (g)
JOT72610	P30N10C	10"	540



JOT703 P30M10A		Straight Jaw Locking Pliers 10"	
Size (inch)	10"	Weight (g)	540
Chrome Vanadium Jaw, Chrome Molybdenum Handle and Nickle Plated			



JOT72709 P36M09C		Long Nose Locking Pliers with TPR Handle 9"	
Item Code	Part No.	Size (inch)	Weight (g)
JOT72709	P36M09C	9"	360



JOT704 P30M09A		Long Nose Locking Pliers 9"	
Size (inch)	9"	Weight (g)	360
Chrome Vanadium Jaw, Chrome Molybdenum Handle and Nickle Plated			



JOT705 P38M11A		Welding Clamps 11"	
Size (inch)	11"	Weight (g)	650
Chrome Vanadium Jaw, Chrome Molybdenum Handle and Nickle Plated			
Deep U-Shaped Jaws Provide Excellent View and Ample working space.			



JOT71508 – JOT71510 P54M08A – P54M10A		Sheet Metal Locking Pliers	
Code	Item	Size (Inch)	Weight (g)
JOT71508	P54M08A	8"	460
JOT71510	P54M10A	10"	650
<ul style="list-style-type: none"> • CR – MO Jaw • Nickel Plated Finish 			



JOT706 & JOT70618 P37M11A & P37M18A		C-Clamp with Standard Tip	
Code	Size (inch)	Weight (g)	
JOT706 (P37M11A)	11"	700	
JOT70618 (P37M18A)	18"	1100	
<ul style="list-style-type: none"> • Nickle Plated Finish • Quick Locking and Unlocking Design • Smooth Pressure Adjustment 			



JOT8008 – JOT80032 M04008 – M04032		Ball Peen Hammer – Fiberglass Handle		
Code	Item No.	Head Weight (oz)	l (mm)	Weight (g)
JOT8008	M04008	8	278±6	395
JOT80012	M04012	12	283±6	527
JOT80016	M04016	16	327±6	780
JOT80024	M04024	24	383±6	1063
JOT80032	M04032	32	385±6	1208



JOT8018 – JOT80132 M08008 – M08032		Ball Peen Hammer – Hickory Handle		
Code	Item No.	Head Weight (oz)	l (mm)	Weight (g)
JOT8018	M08008	8	300±6	375
JOT80112	M08012	12	325±6	444
JOT80116	M08016	16	350±6	584
JOT80124	M08024	24	396±6	1042
JOT80132	M08032	32	400±6	1208



JOT80216 – JOT80220 M05016 – M05020		Claw Hammer Fibre glass Handle		
Code	Item No.	Head Weight (oz)	l (mm)	Weight (g)
JOT80216	M05016	16	330±6	750
JOT80220	M05020	20	330±6	830



JOT80516 – JOT80520 M01016 – M01020		Solid Steel One Piece Claw Hammer		
With Shockwave TPR Grip				
Item	Art. No	Head Wgt (oz)	l (mm)	Weight (g)
JOT80516	M01016	16	321±6	777
JOT80520	M01020	20	346±6	875



JOT8037 – JOT80320 M16007 – M16020		Claw Hammer Hickory Handle	
Code	Item No.	Head Weight (oz)	Overall Length (mm)
JOT8037	M16007	7	292±6
JOT80313	M16013	13	317±6
JOT80316	M16016	16	330±6
JOT80320	M16020	20	343±6



JOT80625 – JOT8064 M03025 – M03040		Hammer With Shockwave TPR Grip		
Item	Art. No	Head Weight (lb)	l (mm)	Weight (g)
JOT80625	M03025	2.5	276±6	1334
JOT8064	M03040	4	276±6	2167



JOT81416 M07016		Soft Face hammer		
TPR Material (Black)				
Transparent Acetate Material				
Head Weight (oz)		l (mm)	Weight (g)	
16		314	840	



JOT81020 M23600		Carpenter's Hammer		
Chrome Plated, Heat Treated Tubular Steel Handle Magnetic Nail Holder				
Head Wgt g (oz)		Overall Length (mm)		
600 (20)		320		



JOT809100 – JOT809800 M22100 – M22800		Joiner's Hammer	
With Hickory Handle			
Item	Art. No	Head mm	Overall Length (mm)
JOT809100	M22100	16	260
JOT809190	M22190	20	280
JOT809450	M22450	28	323
JOT809520	M22520	30	328
JOT809630	M22630	32	330
JOT809800	M22800	35	333



JOT807100 – JOT8071000 M09100 – M091000		DIN Engineers Hammer	
With Hickory Handle			
Item	Art. No	Head Wgt (g)	l (mm)
JOT807100	M09100	100	260±6
JOT807400	M09400	400	300±6
JOT807600	M09600	600	320±6
JOT807800	M09800	800	350±6
JOT8071000	M091000	1000	360±6



JOT80835 – JOT80865 M11035 – M11065		Dead Blow Hammer		
Steel Hammer Grip Covered With Synthetic Rubber				
Item	Art. No	Head Dia (mm)	Overall Length	Weight (g)
JOT80835	M11035	35	260	400
JOT80845	M11045	45	286	520
JOT80855	M11055	55	350	1050
JOT80865	M11065	65	370	1500



JOT901 H07M08SF		8 Pc Star Key Folding Set	
CR-V; Chrome Plated			
CONTENTS:	T9,T10,T15,T20,T25,T27,T30,T40		



JOT893 H01M07SF		7 Pc Hex Key Set (Folding) mm	
• CR-V • Chrome Plated			
H01M07SF	7 Pc: 2.5, 3, 4, 5, 6, 8, 10mm		



JOT463 H10MB08S		8 Pc Two Way Ball Point and Hex Key Set	
Item	Art. No	Size(mm)	
JOT6542100	H10MB2100	2 x 100	
JOT65425100	H10MB25100	2.5 x 100	
JOT6543100	H10MB3100	3 x 100	
JOT6544100	H10MB4100	4 x 100	
JOT6545150	H10MB5150	5 x 150	
JOT6546150	H10MB6150	6 x 150	
JOT6548200	H10MB8200	8 x 200	
JOT65410200	H10MB10200	10 x 200	



JOT449 H10MT09S		9 Pc Two Way Star & Tamperproof Key Set	
Item	Art. No	Size	
JOT449101	H10MT10100	T10x100	
JOT449151	H10MT15100	T15x100	
JOT449201	H10MT20100	T20x100	
JOT449251	H10MT25100	T25x100	
JOT449271	H10MT27150	T27x150	
JOT449301	H10MT30150	T30x150	
JOT449401	H10MT40150	T40x150	
JOT449452	H10MT45200	T45x200	
JOT449502	H10MT50200	T50x200	



**JOT464
H10MT08SP** **8 Pc Two Way Star and Tamperproof Key Set, SNCM+V, Mat Finish**

Contents 8 Pc: T10x100, T15x100, T20x100, T25x100, T27x150, T30x150, T45x200, T50x200

Available Individually (JOT449101 - JOT449502)



**JOT895
H12S110S** **10 Pc Extra Long Arm Star Key Set**

Item	Art. No	Size
JOT89509	H12S09085	T9
JOT89510	H12S10090	T10
JOT89515	H12S15100	T15
JOT89520	H12S20115	T20
JOT89525	H12S25130	T25
JOT89527	H12S27145	T27
JOT89530	H12S30165	T30
JOT89540	H12S40185	T40
JOT89545	H12S45205	T45
JOT89550	H12S50230	T50

KEYS



**JOT654
H10MB08ST** **8 Pc Two Way Ball Point & Hex Key Set**

2 x 100; 2.5 x 100; 3 x 100; 4 x 100; 5 x 150; 6 x 150; 8 x 200; 10 x 200

Available Individually (JOT6542100 - JOT65410200)



**JOT894
H03SM109S** **9 Pc Extra Long Arm Hex Key Set**

Item	Art. No	Size
JOT894a	H03SM115	1.5mm
JOT894b	H03SM120	2mm
JOT894c	H03SM125	2.5mm
JOT894d	H03SM130	3mm
JOT894e	H03SM140	4mm
JOT894f	H03SM150	5mm
JOT894g	H03SM160	6mm
JOT894h	H03SM180	8mm
JOT894i	H03SM1100	10mm

**JOT905
H08S110S** **10 Pc Extra Long Arm Star Tamperproof Key Set**

Item	Art. No	Size
JOT90509	H12ST09	T9
JOT90510	H12ST10	T10
JOT90515	H12ST15	T15
JOT90520	H12ST20	T20
JOT90525	H12ST25	T25
JOT90527	H12ST27	T27
JOT90530	H12ST30	T30
JOT90540	H12ST40	T40
JOT90545	H12ST45	T45
JOT90550	H12ST50	T50



**JOT899
H06SA209S** **9 Pc Extra Long Arm Ball Point Hex Key Set (SAE)**

Item	Art. No	Size
JOT899a	H06S215	1/16"
JOT899b	H06S220	5/64"
JOT899c	H06S225	3/32"
JOT899d	H06S230	1/8"
JOT899e	H06S240	5/32"
JOT899f	H06S250	3/16"
JOT899g	H06S260	1/4"
JOT899h	H06S280	5/16"
JOT899i	H06S2100	3/8"



**JOT900
H06S109S** **9Pc Extra long Arm Ball Point Hex Key (mm)**

Item	Art. No	Size
JOT90002	H06S120	2mm
JOT90003	H06S130	3mm
JOT90004	H06S140	4mm
JOT90005	H06S150	5mm
JOT90006	H06S160	6mm
JOT90008	H06S180	8mm
JOT90010	H06S1100	10mm
JOT90015	H06S115	1.5mm
JOT90025	H06S125	2.5mm

Hand Tool Range



JOT924 M63106S		6 Pc Pin Punch Set			
• Phosphate Sunk Finish					
Item	Art. No	Size	L (mm)	Hex Shank	(g)
JOT924230	M63102	2 x 30	115	8	33
JOT924340	M63103	3 x 40	125	8	34
JOT924450	M63104	4 x 50	150	9.5	63
JOT924555	M63105	5 x 55	165	9.5	71
JOT924655	M63106	6 x 55	180	12.7	132
JOT924860	M63108	8 x 60	180	12.7	144

JOT902 M63M106S		6 Pc Pin Punch Set			
Chrome Plated					
Item	Art. No	Size	L (mm)	Hex Shank	(g)
JOT902230	M63M102	2 x 30	115	8	33
JOT902340	M63M103	3 x 40	125	8	34
JOT902450	M63M104	4 x 50	150	9.5	63
JOT902555	M63M105	5 x 55	165	9.5	71
JOT902655	M63M106	6 x 55	180	12.7	132
JOT902860	M63M108	8 x 60	180	12.7	144

GENERAL TOOLS



JOT904 MHS100AG		Heavy Duty Hacksaw with 12" High Strength Steel Blade			
Special Features:					
• Blade positioned for 45° or 90° Normal Cutting					
• Adjustable Handle to Increase Tension Up To 34000 psi Torque					
• Extra Blades To Be Stored In Top Bar					

JOT914 V1501		Heavy Duty Easy Stripper			
Features:					
• Crimped Type of Terminal					
• Insulated Terminals					
• Non-Insulated Terminals					
• Auto Ignition Terminal					
• Length : 205mm					
• Weight : 305g					



JOT920 - JOT928 M60102 - M60104		Centre Punch			
Item	Art. No	Size	L (mm)	Hex Shank (mm)	
JOT920	M60102	2	120	9.5	
JOT928	M60104	4	120	9.5	

JOT650a - JOT650c M63M106S		Cold Chisel			
Item	Art. No	Size			
JOT650a	M61116	16mm			
JOT650b	M61119	19mm			
JOT650c	M61125	25mm			



JOT903 MK2040		Retractable Utility Knife with 2 Pc Blade			
Special Features:					
• Oil Resistance					
• Rubber Paint for Non-Slip Function					
• Cold Resistance to -20°					
• Quick Change Blade Function					

JOT10003 – JOT10008 MT0301 – MT0305		Measuring Tapes			
JOT10003	MT0301	3M			
JOT10005	MT0302	5M			
JOT10008	MT0304	8M			

Hand Tool Range



JOT650 AG0100265C	5 Pc Hammer & Chisel Set
M09300	1 Pc 300g Edging Hammer
M11035	1 Pc 400g Rubber Hammer
M61	3 Pc Cold Chisel Set



JOT657 M6451145C	14 Pc Hacksaw, Chisel, Punch, Wrench Set
M63	6 Pc – Pin Punch Set, Black Finish – 2x8x115mm, 3x8x125mm, 4x9.5x150mm, 5x9.5x165mm, 6x12.7x180mm, 8x12.7x180mm
M64	4 Pc – Chisel Punch Set, Black Finish Taper Punch: 3x9.5x120mm Center Punch: 2x9.5x120mm Cape Chisel: 5x9.5x130mm Cold Chisel: 12x9.5x130mm
W27AS10	1 Pc – 10" Adjustable Wrench With SAE and mm Scale
MHS100AG	3 Pc – Hacksaw Set: 1 Pc Heavy Duty Deluxe Type Hacksaw & 2 Pc Spare Saw Blade



JOT907 V1310A	Smart Vise Crimper – Insulated Terminals
<ul style="list-style-type: none"> • HRC 48°-52° Middle Carbon Steel Body with Comfortable TPR Handle. • Length – 9-3/4" (247mm) • Weight – 500g 	

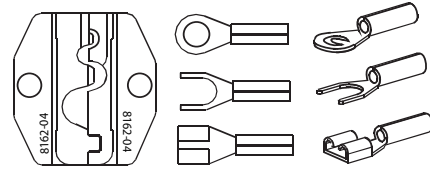

JOT911 V1310E	Smart Vise Crimper – 6 Position Modular Plugs
<ul style="list-style-type: none"> • RJ-11 TWO, FOUR AND SIX POSITION MODULAR PLUGS 	

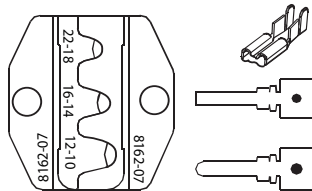

JOT908 V1310B	Crimp Tool Smart Vise Crimper – Barrel Connectors
<ul style="list-style-type: none"> • Usable For Non-Insulated Terminals/Colour Code Nests • 22-10 AWG (0.324mm-5.261mm) 	

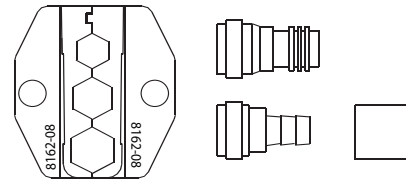

JOT910 V1310D	Smart Vise Crimper – CATV Connectors
<ul style="list-style-type: none"> • Usable for RG-59, RG-6 F TYPE • CATV CONNECTORS HEX 0.35(8.89mm), 0.32(8.13mm), 0.255(6.48mm) 	

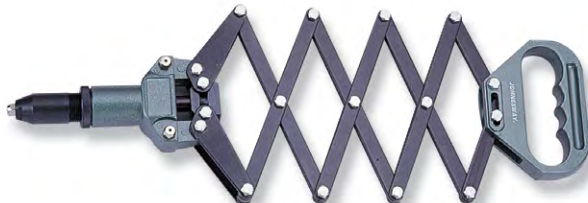

JOT915 V1002	Scissor Action Industrial Riveter
Made of Durable High Carbon Steel.	
4 Nose Pieces: 2.4mm (3/32"), 3.2mm (1/8"), 4.0mm(5/32") 4.8mm (3/16")	

Available Consumables:	
JOT915ap (V1002-16) - Set of 2 Jaws	
JOT915aa (V1002-01) - Set of 4 Nozzle Pieces	



JOT906 V1004	Free Suction Hand Riveter
Head Rotates 360° For Any Angle Riveting	
4 Nose Pieces: 2.4mm(3/32"), 3.2mm(1/8"), 4.0mm(5/32"), 4.8mm(3/16")	

Available Consumables:	
JOT906ah (V1004-8) - Jaws for Free Suction Hand Riveter	



JOT916 V1101	Professional Riveter Nut Tool Kit
Sheet Iron Body, PVC Hand Grips includes Mandrels and Nose Pieces.	
Metric Size: M3, M4, M5, M6	

Available Consumables:	
JOT916al (V1101-12-1) - Nose Piece 6mm	
JOT916am (V1101-12-2) - Nose Piece 5mm	
JOT916an (V1101-12-3) - Nose Piece 4mm	
JOT916ao (V1101-12-4) - Nose Piece 3mm	
JOT916ap (V1101-13-1) - Threaded Mandrel 6mm	
JOT916aq (V1101-13-2) - Threaded Mandrel 5mm	
JOT916ar (V1101-13-3) - Threaded Mandrel 4mm	
JOT916as (V1101-13-4) - Threaded Mandrel 3mm	



JOP1000 – JOP1001		1/4" & 1/2" FRL			
JAZ0502 – JAZ0504		Combination Unit			
Item	Art No	Port Size	Flow Rate	Pressure	Filter
		RC (PT)	l/min (ANR)	Range	Gauge
				kgF/cm ² (kpa)	
JOP1000	JAZ0502	1/4"	1000	0.5-8.5 (50-850)	5µm
JOP1001	JAZ0504	1/2"	3000	0.5-8.5 (50-850)	5µm



JOS001 JA-6111	Deluxe Professional Gravity Feed Spray Gun	
Air Pressure	3.5 – 5 Bar	50-70 psi
Air Inlet	1/4"	
Fluid Inlet	M16 x 1.5P	
Air Consumption	14 cfm	396 l/min
Weight	1.54 lbs	0.7 kg
Capacity of Cup	0.6L	
Type of Cup	NYLON	
Standard Fluid Tip Size	1.4mm	
LENGTH X Height mm	170 x 325	
Feed Type	Gravity	

JOS050 JA6111N	1.4mm Nozzle Set for JA-6111
-----------------------	-------------------------------------

JOS051 JA0001RK	Gasket & Spring Set for JA-6111
------------------------	--



BLACK STEEL is the world's fastest growing brand in the manufacturing of vices, g-clamps and related accessories and comes imported from one of the top steel production countries, India.

The following products are available in the BLACK STEEL range:

- Engineering vices
- Pipe jaw vices
- Drill Press vices
- Woodworkers vices
- Offset vices
- G-clamps
- Jaw covers
- Swivel bases

All BLACK STEEL products are made with precision from the highest quality unbreakable materials and comes with a lifetime guarantee.

BLACK STEEL vices are manufactured from spheroidal graphite (SG) iron. Increased shock resistance, higher mechanical strength, and ductility qualifies BLACK STEEL to be among the strongest vices available on the market today.

Only the best sourced raw materials can produce a superior quality world class product like BLACK STEEL.

For more information on your nearest Black Steel distributor, visit www.gondolier.co.za or email info@gondolier.co.za

PRECISION ENGINEERED





VICES, G-CLAMPS & ACCESSORIES



BSV047-BSV050 TGM-10704 - 10708 SG Iron Extra Strong Fixed Base Vice

Made from unbreakable SG steel.
Fine machine anvil
Floating nut for precise alignment
Two holding down screws lock the vice firmly in any position ensuring maximum stability
Perfect meshed and machined replaceable jaws
Smooth operation
Black hammered finish
Removable Handle.

Item	Size (Inch)	Jaw Width (mm)	Jaw Opening (mm)	Throat Depth (mm)	Weight (kg)
BSV047 (TGM-10704)	4"	103	107	55	4.2 kg
BSV048 (TGM-10706)	6"	155	152	88	11 kg
BSV050 (TGM-10708)	8"	205	208	96	14.4 kg

BSV001 - BSV004 TGMV-56/4 - 56/8 Professional Fixed Base Vice

Made from unbreakable SG steel.
Extra large fine machined anvil
Grub screws to secure base
Extended base for extra support and stability
Floating nut for precise alignment
Incorporated with oiling point
Two holding down screws lock the vice firmly in any position ensuring maximum stability.
Optional accessories, detachable nylon or aluminium jaws.

Item	Size (Inch)	Jaw Width (mm)	Jaw Opening (mm)	Weight (kg)
BSV001 (TGMV-56/4)	4"	102	103	7 kg
BSV003 (TGMV-56/6)	6"	156	162	17 kg
BSV004 (TGMV-56/8)	8"	206	219	26.7kg



BSV005 - BSV008 TGM-10324 - 10328 Professional Swivel Base Vice

Made from unbreakable SG steel.
Extra large fine machined anvil
Grub screws to secure base
Extended base for extra support and stability
Floating nut for precise alignment
Incorporated with oiling point
Two holding down screws lock the vice firmly in any position ensuring maximum stability
Optional accessories, detachable nylon or aluminium jaws.

Item	Size (Inch)	Jaw Width (mm)	Jaw Opening (mm)	Throat Depth (mm)	Weight (kg)
BSV005 (TGM-10324)	4"	102	103	70	8 kg
BSV007 (TGM-10326)	6"	156	162	102	19 kg
BSV008 (TGM-10328)	8"	206	219	110	28.2 kg

BSV009 TGMV-75/7 Woodworker's Vice 7"

Made from unbreakable SG steel.
Jaws machined out of one piece of material resulting in a perfect match.
Removable / replaceable handle with rubber washers for added comfort.
"Quick release" features allows the jaws to be opened or closed without using the main spindle just by precising the trigger which result in precious time saving.
Adjustable "peg/dog" allows long piece or timber to be held against a stop on the bench top while planning, routing, chiseling etc.

Item	Size (Inch)	Jaw Width (mm)	Jaw Opening (mm)	Weight (kg)
BSV009 TGMV-75/7	7"	175	175	9.8 kg

Black Steel Range



BSV032 - BSV033
TGMV-61/4P - 6P **Drill Press Vice**

Made from unbreakable SG steel.
Jaws machined from one piece of material resulting in a perfect match.
Removable / Replaceable handle with rubber washers.

Item		Size (Inch)	Jaw Width (mm)	Jaw Opening (mm)	Weight (kg)
BSV032	TGMV-61/4P	4"	100	100	7.8 kg
BSV033	TGMV-61/6P	6"	150	150	16 kg



BSV053-BSV054
TGM-10706-H **Handles for workshop Vices**

Item	Size
BSV053 (TGM-10706-H)	150mm
BSV054 (TGM-10708-H)	200mm



BSV018 - BSV021
TGMV-56/6SB - TGMV-56/ 56/8SB **Swivel Bases**

Made from unbreakable SG steel.
Swivel base can rotate up to 360 degrees.
Two screws lock the vice firmly in any position, ensuring maximum stability

Item		Description	Size mm	Weight
BSV018	TGMV - 56/6SB	Swivel base for BSV003	150	1 kg
BSV019	TGMV - 56/4SB	Swivel base for BSV001	100	1.5 kg
BSV021	TGMV - 56/8SB	Swivel base for BSV004	200	2.3 kg



BSV015-BSV016
TGM-FJ4 - TGM-FJ6 **Nylon (PVC) Jaw Covers**

Made from high quality CRC sheet C/P and superior quality ABS.
Two screws lock the covers firmly in position ensuring maximum stability.

Item	Size	Jaw Width	Weight
BSV015 (TGM - FJ4)	4"	100mm	0.11 kg
BSV016 (TGM - FJ5)	5"	125mm	0.18 kg

BSV022-BSV028
TGM-26202 - TGM-26210 **G-Clamps SG Iron**

Made from unbreakable SG steel.
Perfect mesh.
Ball joint swivel pad.
ACME Thread spindle, chrome plated to resist corrosion.

Item	Art No.	Size (Inch)	Jaw Width (mm)	Weight
BSV022	TGM-G-C/P/2	2	50	0.7 kg
BSV023	TGM-G-C/P/3	3	75	0.85 kg
BSV024	TGM-G-C/P/4	4	105	1.6 kg
BSV025	TGM-G-C/P/6	6	150	1.7 kg
BSV026	TGM-G-C/P/8	8	205	2.2 kg
BSV027	TGM-G-C/P/10	10	245	2.6 kg
BSV028	TGM-G-C/P/12	12	305	3.3 kg



BSV012-BSV013
TGMV-AJ4 - TGMV-AJ6 **Aluminium Jaw Covers**

Made from high quality CRC sheet C/P and superior quality aluminium.
Jaws Meshed from one piece of material resulting in a perfect mesh.

Item	Size	Jaw Width	Weight
BSV012 (TGM - AJ4)	4"	100mm	0.140 kg
BSV013 (TGM - AJ5)	5"	125mm	0.260 kg



BSV040 - BSV046
TGMJ-SJHD/4 - TGMJ-SJ/6 **Jaws with fixing bolts**

Made from unbreakable SG steel

Item	Size	Weight
BSV040 (TGMJ - SJ HD/4)	100mm	0.45 kg
BSV041 (TGMJ - SJ HD/5)	125mm	0.95 kg
BSV042 (TGMJ - SJ HD/6)	150mm	1.05 kg
BSV043 (TGMJ - SJ HD/8)	200mm	1.45 kg
BSV044 (TGMJ - SJ/4)	100mm	0.4 kg
BSV045 (TGMJ - SJ/5)	125mm	0.6 kg
BSV046 (TGMJ - SJ/6)	150mm	0.7 kg

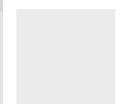
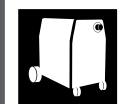

TEMPIR

MIG WELDING • PLASMA CUTTING • SPOT WELDING

TEMPIR comes imported from Taiwan and the factory was founded in 1986. The company have developed a world class research centre with academic support by professionals with masters and doctors degrees in electronics.

They signed a technology cooperation contract with the Industrial Technology Research division of the National Taiwan University for science and technology. This has led to the transformation of advanced development in the range resulting in the production of superior quality equipment.

The company owns many patents for its innovations. A bigger factory was build in 2004 with a total of over 7000m² insuring a production capacity that keeps up with world demand.

We proudly introduce to you the following models:

- Mig 155 S/PH, 150A (TEM002)
- Mig 190 3/PH, 200A (TEM004)
- Mig 2612 S/PH, 250A (TEM005)
- Mig TRI 213 3/PH, 200A (TEM006)
- Mig 2932 3/PH, 290A (TEM007)
- Plasma P55 3/PH, 50A (TEM010)
- Plasma P80 3/PH, 40A / 80A (TEM011)
- Spot 3888 S/PH, 3000A (TEM012)
- Mig/Mag 4032C, 400A (TEM013)
- Digital Hybrid Plastic Welder S/PH, 230V (TEM014)
- Cut 40 HF 220V Inverter Cutter (TEM015)
- Mig 1901 NP S/PH (TEM017)

For more information on your nearest Tempir distributor, visit www.gondolier.co.za or email: info@gondolier.co.za

Manufactured in a world class production facility.

PATENTED
For many leading innovations.



**SUPERIOR QUALITY
WELDING EQUIPMENT**





TEM002 13053-5E		MIG 155 S/PH, 150A	
Single Phase	230V 50 / 60 Hz	Wire Size	0.6 - 1.0mm
Input Power	5kVA	Spool	200mm
Steps	6 Steps	Weight	28 kg
Amps	150 A	Dimensions	539 x 300 x 575mm
Duty Cycle	120A 25% 95A 40% 60A 100%	Description	Compact Euro Type

TEM004 1321-9E A		MIG 190 3/PH, 200A	
Three Phase	230 /400V 50 / 60Hz	Wire Size	0.6 - 1.0mm
Input Power	6kVA	Spool	300mm
Steps	7 Steps	Weight	60 kg
Amps	200 A	Dimensions	780 x 345 x 620mm
Duty Cycle	135A 40% 110A 60% 85A 100%	Description	Compact Euro Type

TEM005 13272-12E		MIG 2612 S/PH, 250A	
Single Phase	230V 50 / 60 Hz	Wire Size	0.6 - 1.2mm
Input Power	10kVA	Spool	300mm
Steps	10 Steps	Weight	84 kg
Amps	250 A	Dimensions	810 x 385 x 800mm
Duty Cycle	260A 25% 220A 40% 140A 100%	Description	Compact Euro Type

TEM017 13102-C-02		MIG 190 EVO S/PH, 160A	
Single Phase	230V 50/60Hz	Wire Size	0.6 - 1.0mm
Input Power	6kVA	Spool	300mm
Steps	6 Steps	Weight	49 kg
Amps	29A-160A	Dimensions	960 x 360 x 630mm
Duty Cycle	130A 30% 85A 60% 65A 100%	Description	Compact Euro Type

TEM006 1321-501E		MIG TRI 213 3/PH, 200A	
Three Phase	230 / 400V 50 / 60 Hz	Wire Size	0.6 - 1.0mm
Input Power	10kVA	Spool	300mm
Steps	14 Steps (2x7)	Weight	100 kg
Amps	200 A	Dimensions	855 x 400 x 835mm
Duty Cycle	200A 60% 150A 100%	Description	Compact Euro Type

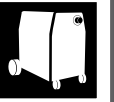

TEM007 1324A-2E		MIG 2932 3/PH, 290A	
Three Phase	230/400V 50 / 60 Hz	Wire Size	0.6 - 1.2mm
Input Power	11KVA	Spool	300mm
Steps	14 Steps (2x7)	Weight	90 kg
Amps	290 A	Dimensions	810 x 380 x 800mm
Duty Cycle	290A 25% 235A 60% 185A 100%	Description	Compact Euro Type



TEM013 13642-E		MIG/MAG 4032C, 400A	
Three Phase	380 V 50 / 60 Hz	Wire Size	0.6 - 1.2 (1.6) mm
Input Power	21 KVA	Spool	300mm
Steps	30 Steps	Weight	130 kg
Amps	400 A	Dimensions	470 x 1000 x 770mm
Duty Cycle	400A 30% 283A 60% 219A 100%	Description	Compact Euro Type



TEM010 1555-8E		PLASMA P55 3/PH, 50A	
Three Phase	230 / 400 V 50 / 60 Hz	Duty Cycle	50A 40%
Input Power	15 KVA	Max Cutting Thickness	15mm
Steps	1 Step	Weight	50 kg
Amps	50 A	Dimensions	415 x 380 x 770mm



TEM011 1580-6E		PLASMA P80 3/PH, 40	
Three Phase	230 V 50 / 60 Hz	Duty Cycle	50A 40%
Input Power	22 kVA	Max Cutting Thickness	25mm
Steps	2 Steps	Weight	101 kg
Amps	40 A / 80 A	Dimensions	480 x 470 x 820mm



TEM015 1721-B - 01		Cut 40 HF 220V Inverter Cutter	
Single Phase	230 V 50 / 60 Hz	Max Cutting Thickness	8mm
Input Power	6 kVA	Duty Cycle	40A 60% 30A 100%
Amps	40 A	Weight	10 kg
Power	Micro Adjustment	Dimensions	355 x 150 x 295mm



TEM012 1111-17E		Single SPOT Dent Puller 3888 S/PH, 3000A	
Single Phase	230V 50 / 60 Hz	Duty Cycle	3000A 5%
Input Power	12kVA	Weight	25 kg
Adjustment	Micro - adj	Dimensions	345 x 205 x 235mm
Amps	3000A		



TEM014 19272A-C-01		Digital Hybrid Plastic Welder S/PH, 230V	
Single Phase	110V / 230V	Stapling & Welding	Yes
Adjustment with switches	4 Steps	Welding Mode	Fast Heating/ Cooling
Max Output Current	65A (welding)	Weight	4kg

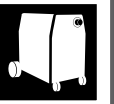

TEMPIR

MIG WELDING • PLASMA CUTTING • SPOT WELDING

MIG WELDING, PLASMA CUTTING & SPOT WELDING

Welding Equipment

SURFACE PROTECTION FROM GRINDING SPARKS, WELDING SPATTER AND OPEN FLAMES

- Blankets come in a 2m x 2m size and fixes easily in place with masking tape.
- Time efficient as it eliminates the need to strip and assemble.
- Non-flammable, withstanding temperatures far in excess of sparks and spatter.
- Soft, non-abrasive blanket-like feel. Will not scratch or scuff the most delicate of finishes.
- Easy-to-handle, lightweight fiber material.
- Non-toxic - produces no toxic gases when exposed to heat or flame.
- Easy to clean by shaking out or light brushing.

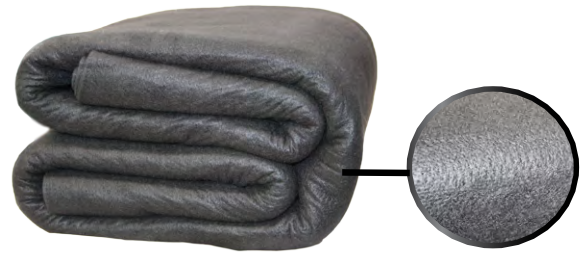

TEM300	Tempir Welding Blanket
Size:	2m x 2m
Thickness:	5mm
Weight:	700g+-20g/m2
Raw Material:	100% Pyron
Temperature:	1000° Fahrenheit, 537° Celsius

* Custom sizes available, enquire with your size requirement. (Width a fixed length of 2m, length is variable.)

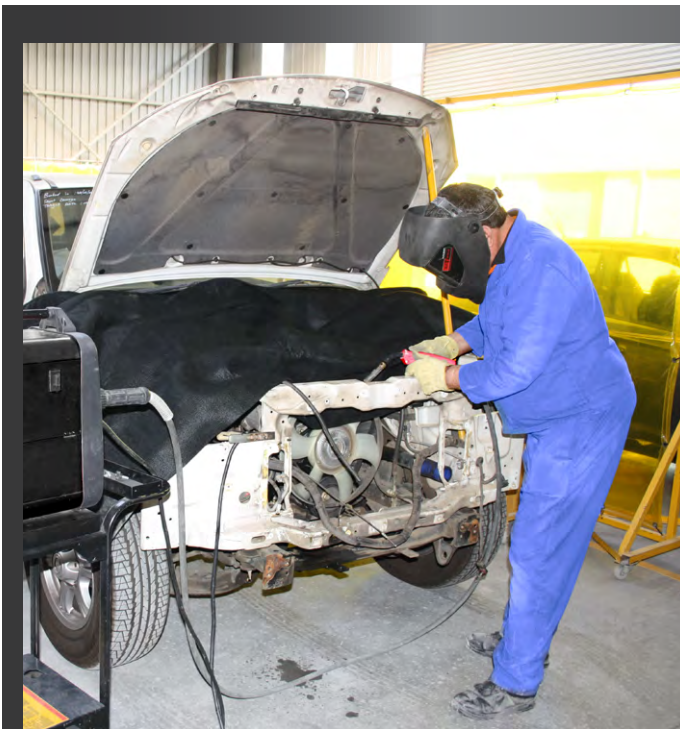



TECNA

SPOT WELDING EQUIPMENT



Optional Extras:

- Water cooling
- Arms as per specification

Information:

- For high operating rate works in car body repair shops and light production works in Industry.
- Fully water-cooled portable spot gun to be used with arms.
- Versatile portable spot welder for auto body repair and maintenance shops.
- Synchronous built-in electronic timer with SCR from 2 to 65 cycles.
- Compensation circuit starts the timer only when there is a proper passage of current, which enables it to perform on oxidized sheets, on surfaces with paint residues or on black sheets.
- Current control with phase shift adjustment to carry out difficult welds, on very thin thickness, on rods with reduced diameter, on stainless steel sheet and similar.
- Cos fi control.
- Force adjustment with scale in daN.
- Additional arm couplings to provide larger opening between arms. Large choice of arms and electrodes.
- All transformers are coated with F class insulation material. Test are made using 4000 volts.

TEC022 - TEC023 7903/400/50 - 7903/230/50	Portable 6KVA Watercooled Spot Welder	
TECHNICAL INFORMATION:	TEC022	TEC023
Phases	3 Phase	Single Phase
Time adjustment	2-65 cycles	2-65 cycles
Supply voltage 50Hz*	400 V	400 V
Nominal power at 50%	6 kVA	6 kVA
Maximum welding power	16 kVA	16 kVA
Short circuit current with arms L=	8.2 kA 125mm	8.2 kA 125mm
Thermal current 100%	1700 A	1700 A
No load secondary voltage	2.5 V	2.5 V
Insulation class	F	F
Cables section for L< 15m	2.5 mm ²	2.5 mm ²
Delayed fuses	16A	16A
Max. electrode force with arms L=	120daN 125mm	120daN 125mm
Arms gap	94mm	94mm
Max. electrodes stroke with arms L=	70mm 150mm	70mm 150mm
Water cooling	3.7 l/min	3.7 l/min
Water max. pressure	2.5 bar	2.5 bar
Aerial noise produced	< 70 dB(A)	< 70 dB(A)
Level of vibrations	< 2.5m/s ²	< 2.5m/s ²
Measure of welding time	20 cycles	20 cycles
Measure of welding current	6 kA	6 kA
working rating of weld/min	2	2
Mains cable lenght	3.8m	3.8m



TEC337 7902P		Hand Held Double Sided Spot Welder	
Nominal Primary Voltage/Frequency	400V 50Hz	Primary cross section cable L+15m	2.5 mm ²
Normal Power at 50%	2.5 kVA	Nominal Current	1.0 kA
Continuous Power	1.77 kVA	Continuous Current	0.7 kA
Max. Short Circuit Power	20.5 kVA	Short Circuit Current	8.20 kA
Max. Welding Power	16 kVA	Max Welding Current	6.55 kA
Secondary No Load Voltage	2.5 kVA	Duty Cycle with max. weld current	1.1%
Connection Power	13.5 kVA	Dimensions	90 x 370 x 230 mm
Delayed Fuses	16A	Net Weight	11kg



ALUMINIUM BAY



• 2 Pillar (Wall mounted)



• 4 Pillar (Free Standing)

Features:

- E-Glass Curtain System.
- Manufactured to required specification with E-Glass Compound, fire protected, fitted with a viewing window.
- Made with TTV-RED-RW eye protection.
- Aluminium rail system with rails and rollers.
- Self assembly, easy installation.

Customized options available, submit your specifications for a quotation.

SPA001	2 Pillar Aluminium Bay
Includes:	
<ul style="list-style-type: none"> • 3 x Aluminium Rails including 36 rollers on the rails. • 2 x Vertical poles with base plates, gussets, bolts and nuts. • 3 x Glass Fibre 550° C Fire Blankets (4m x 2.77m) incorporating a red welding screen strip of 500mm in the middle. 	

SPA002	4 Pillar Aluminium Bay
Includes:	
<ul style="list-style-type: none"> • 4 x Aluminium Rails including 48 rollers on the rails. • 4 x Vertical poles with base plates, gussets, bolts and nuts. • 4 x Glass Fibre 550° C Fire Blankets (4m x 2.77m) incorporating a red welding screen strip of 500mm in the middle. 	

WELDING SCREENS



Screens available in yellow & red.



Custom sizes made to requirement.

Features:

- Durable material
- Prevents Ark Eyes
- Filters damaging UV lights
- Self extinguishing
- Easy to secure with eyelets
- Complies to health & safety regulations.

SPA015y/r SPA016y/r	Complete Welding Screen	
Protective sheet on a frame with wheels.		
Size	Code -Yellow	Code - Red
2m x 2m	SPA015y	SPA015r
2m x 3m	SPA016y	SPA016r

SPA010y/r SPA014y/r	Protective Sheets (only)	
Size	Code -Yellow	Code - Red
2m x 2m	SPA010y	SPA010r
2m x 3m	SPA011y	SPA011r
3m x 3m	SPA012y	SPA012r
3m x 1.5m	SPA013y	SPA013r
1.8m x 2.4m	SPA014y	SPA014r

Aluminium Bay



Professional point of sale material available to all outlets stocking JONNESWAY Professional Tool Range and BLACK STEEL Vices, G-clamps and accessories.



Store concepts and product ranges can be adjusted to suit individual shop requirements.

Various retail environments can benefit from the range of displays, signage, counter stands and floor stands available, a solution to maximise any space effectively can be offered. Enquire about our industry specific retail stand offers.



Conversion Tables

Newton-Meter Nm in Foot-Pounds lbf.ft.

Nm	0	1	2	3	4	5	6	7	8	9
	ft- lbs.									
0	0	0.74	1.48	2.21	2.95	3.69	4.43	5.17	5.9	6.64
10	7.38	8.12	8.86	9.59	10.33	11.07	11.81	12.54	13.28	14.02
20	14.76	15.5	16.2	16.97	17.71	18.45	19.19	19.93	20.65	21.4
30	22.14	22.88	23.62	24.35	25.1	25.83	26.57	27.31	28.04	28.78
40	29.52	30.26	31	31.73	32.47	33.21	33.95	34.69	35.42	36.16
50	36.9	37.64	38.38	39.11	39.85	40.59	41.33	42.07	42.8	43.54
60	44.28	45.02	45.76	46.49	47.23	47.97	48.71	49.45	50.18	50.92
70	51.66	52.4	53.14	53.87	54.61	55.35	56.09	56.83	57.56	58.3
80	59.04	59.78	60.52	61.25	62	62.73	63.47	64.21	64.94	65.68
90	66.42	67.16	67.9	68.63	69.37	70.11	70.85	71.59	72.32	73.06
100	73.8	74.54	75.28	76.01	76.75	77.49	78.23	78.97	79.7	80.44

Millimeters to inches

mm	1	10	20	30	40	50	60	70	80	90
0	0.00	0.39	0.79	1.18	1.57	1.97	2.36	2.76	3.15	3.54
100	3.94	4.33	4.72	5.12	5.51	5.91	6.30	6.69	7.09	7.48
200	7.87	8.27	8.66	9.06	9.45	9.84	10.24	10.63	11.02	11.42
300	11.81	12.20	12.60	12.99	13.39	13.78	14.17	14.57	14.96	15.35
400	15.75	16.14	16.54	16.93	17.32	17.72	18.11	18.50	18.90	19.29
500	19.69	20.08	20.47	20.87	21.26	21.65	22.05	22.44	22.83	23.23
600	23.62	24.02	24.41	24.80	25.20	25.59	25.98	26.38	26.77	27.17
700	27.56	27.95	28.35	28.74	29.13	29.53	29.92	30.31	30.71	31.10
800	31.50	31.89	32.28	32.68	33.07	33.46	33.86	34.25	34.65	35.04
900	35.43	35.83	36.22	36.61	37.01	37.40	37.80	38.19	38.58	38.98

Length

1 centimeter (cm)	= 10 mm	= 0.3937 in
1 metre (m)	= 100 cm	= 1.0936 yd
1 kilometre (km)	= 1000 m	= 0.6214 mile
1 inch (in)	= 2.54 cm	
1 yard (yd)	= 36 in	= 0.9144 m
1 mile	= 1 760 yd	= 1.6903 km

Force / unit length

pound per linear foot	N/m	14.59
per linear foot	kN/m	14.59

Bending moment, torque, moment of force

ft - lb	N/m	1.356
ft - kip	kN/m	1.356

Temperature

°C	°F
0	32
5	41
15	59
20	68
30	86
40	104
50	122
60	140
70	158
80	176
90	194
100	212
C into F = C x 1,8 + 32 = F	
F into C = F - 32 : 1,8 = C	

Force (Pressure or stress)

kip per square inch (ksi)	megapascal (MPa)	6.894
pound per square foot (psf)	kilogram per square meter (kg/sq m)	4.882
pound per square foot (psf)	pascal (Pa)	47.88
pound per square inch (psi)	pascal (Pa)	6894.757
pound per square inch (psi)	megapascal (MPa)	0.00689476

Units of Measurement

Gauge	Metal Thickness	gauge (mm)
Foot / lbs	Torque	newton-meter (N/m)
lbs/sq.in	Pressure	kilopascal (kPa)
		megapascal (MPa)
Kips; Ksi	Tension	kilopascal (kPa)
		megapascal (MPa)

ISO International Metric Abbreviations

Length	Metre	m		
Mass	Kilogramme	kg		
Time	Second	s		
Force	Newton	N	=kg m/s ²	1N=0,102 kp
Torque	Newtonmeter	Nm		9,81 Nm = 1kpm
Energy (work)	Joule	J	=Nm	
Heat quantity	Joule	J		1J = 0.239 cal
Power	Watt	W	=Nm/s	1kW=1,36 PS = 860 kcal/h
Pressure	Pascal	Pa	=Nm ²	100 000 Pa = 1bar=10mWS
Electric current	Ampere	A		

Torque Conversion Factors

given measurement	desired measurement					
	=Ncm	=Nm	=Kpcm	=kpm	=lbf.in.	=lbf.ft
Ncm	1	0,01	0,10197	0,00102	0,0885	0,00738
Nm	100	1	10 197	0,10197	8 851	0,7376
kpcm	9 807	0,09807	1	0,01	0,868	0,0723
kpm	980,07	9 807	100	1	86 796	7 233
lbf.in.	11 298	0,11298	1 152	0,01152	1	0,0833
lbf.ft.	135,58	13 558	13 825	0,13825	12	1



**KEEP
CALM
AND
USE
JONNESWAY®
PROFESSIONAL TOOL RANGE**





JONNESWAY®
PROFESSIONAL TOOL RANGE

ON Wheels!



JONNESWAY®
PROFESSIONAL TOOL RANGE

- Professional Hand Tools
- Brake, Suspension & Undercar Tools
- Pneumatic Tools
- Engine Service Tools
- Body Tools
- General Tools
- Electronic Tools
- Spray Painting Equipment



**VICES,
G-CLAMPS
& ACCESSORIES**

- Drill Press Vice
- Offset Vice
- Woodwork Vice
- Pipe Jaw Vice
- Engineering Vice
- Jaw covers
- Swivel bases

TEMPIR

MIG WELDING • PLASMA CUTTING • SPOT WELDING

- Mig Welders
- Plasma Cutters
- Dent Pullers
- Plastic Welders
- Welding Blankets

TECNA

SPOT WELDING EQUIPMENT

- Hand Held Spot Welders

**SPACE
BAY**

- Welding Screens

